

3440 - Single Phase (1 Ph)

Single Phase Multi-function Digital Meter
Installation & Operating Instructions

Section	Contents
1.	Introduction
2.	Measurement Reading Screens
3.	Programming
3.1	Password Protection
3.2	Menu selection
3.2.1	System Parameter selection screen
3.2.1.1	Potential transformer Primary value
3.2.1.2	Potential transformer Secondary value
3.2.1.3	Current transformer Primary value
3.2.1.4	Current transformer Secondary value
3.2.1.5	Demand integration time
3.2.1.6	Auto Scrolling
3.2.1.7	Low current noise cutoff
3.2.2	Communication Parameter selection screen
3.2.2.1	Address Setting
3.2.2.2	RS 485 Baud rate
3.2.2.3	RS 485 Parity selection
3.2.3	Reset Parameter selection screen
3.2.3.1	Resetting Parameter
3.2.4	Output Option selection screen (menu)
3.2.4.1	Configuration of Output
3.2.4.1.1	Relay 1 output selection menu
3.2.4.1.1.1	Pulse output
3.2.4.1.1.1.1	Assignment of Energy to Pulse (Relay 1)
3.2.4.1.1.1.2	Pulse Duration Selection
3.2.4.1.1.1.3	Pulse Rate
3.2.4.1.1.2	Limit output
3.2.4.1.1.2.1	Assignment of Limit Output1 to Parameter
3.2.4.1.1.2.2	Limit Configuration
3.2.4.1.1.2.3	Trip point selection
3.2.4.1.1.2.4	Hysteresis selection
3.2.4.1.1.2.5	Energizing delay time
3.2.4.1.1.2.6	De-energizing delay time
3.2.4.1.2	Relay 2 output selection menu
3.2.4.1.3	Analog output
3.2.4.1.3.1	Parameter setting for Analog Output-1
3.2.4.1.3.2	Parameter setting for Analog Output-2
3.2.5	Quit screen
4.	Run - Hour.
5.	On - Hour.
6.	Number of Interruption
7.	Analog Output
8.	Relay Output
8.1	Pulse output
8.2	Limit Switch
9.	RS 485 (ModBus)
9.1	User Assignable Modbus Register
10.	Phaser Diagram
11.	Installation
11.1	EMC Installation Requirements
11.2	Case Dimensions and Panel Cut-out
11.3	Wiring
11.4	Auxiliary Supply
11.5	Fusing
11.6	Earth / Ground Connections
12.	Connection Diagrams
13.	Specification
14.	Connection for Optional Pulse output / RS/ 485 Analog Output

15030734 Rev.C/12/11

1. Introduction

The 3440 is a panel mounted 48 x 48 mm DIN Quadratic Digital metering system for the measurement important electrical parameters like AC Voltage, AC Current, Frequency, Power, Energy(Active / Reactive / Apparent) . The instrument integrates accurate measurement technology) Voltage & Current measurements are True RMS upto 15th Harmonic (with 7 line 7 digits ultra high Brightness LED display.

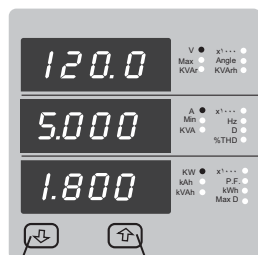

The front panel has two push buttons through which the user may scroll through the available measurement readings ,reset the energy (Import/Export(Min/Max) System Voltage and System Current (and configure the product.

TABLE:1

Measured Parameters	Units of measurement
System Voltage	Volts
System Current	Amps
Frequency	Hz
System Active Power	Kwatts
System Reactive Power	KVAr
System Apparent Power	KVA
System Power Factor	—
Phase Angle	Degree
Active Import Energy (8 Digit resolution)	kWh
Active Export Energy (8 Digit resolution)	kWh
Reactive Import Energy (8 Digit resolution)	kVArh
Reactive Export Energy)^ Digit resolution(kVArh
Apparent Energy)^ Digit resolution(kVAh
Ampere Hour)^ Digit resolution(KAh
Current Demand	Amps
KVA Demand	KVA
KW Import Demand	KW
KW Export Demand	KW
Max Current Demand	Amps
Max kVA Demand	KVA
Max KW Import Demand	KW
Max KW Export Demand	—
Run Hour	—
On Hour	—
Number of Interruptions	—
V \ THD	%
I \ THD	%

2 .Measurement Reading Screens

In normal operation the user is presented with one of the measurement reading screens out of several screens .These screens may be scrolled through one at a time in incremental order by pressing the ↑Up key "and in decremental order by pressing the ↓Down key."

Screen : 1 System screen (system Voltage ,System Current , System Active Power)

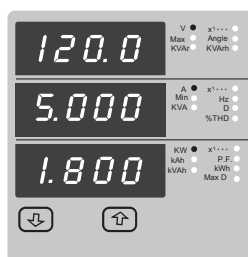

Screen : 2 Phase Angle , Frequency , Sys. Power Factor

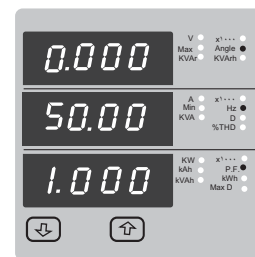

Screen : 3 System Power (Reactive ,Apparent ,Active)

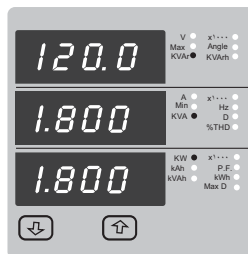

Screen : 4 Active Energy(Import)

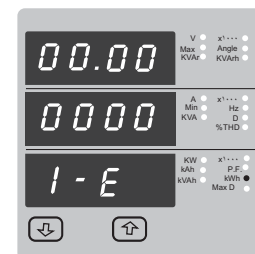

Screen : 5 Active Energy (Export)

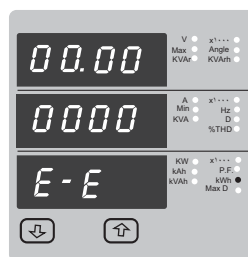

Screen : 6 Reactive Energy(Import)

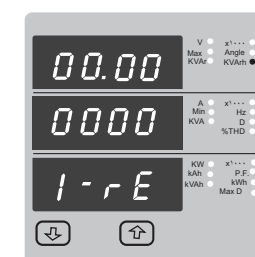

DownKey UpKey

Screen : 0 Reactive Energy(Export)

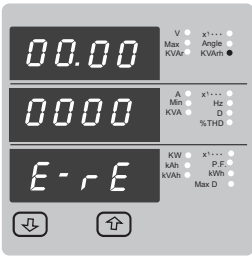

Screen : 1 Apparent Energy

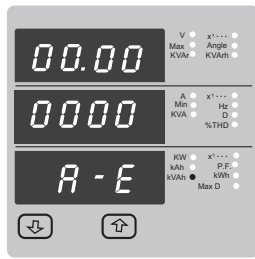

Screen : 2 kVA Demand , Max kVA Demand

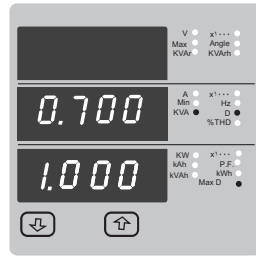

Screen : 3 Import kW Demand / Max Import kW Demand

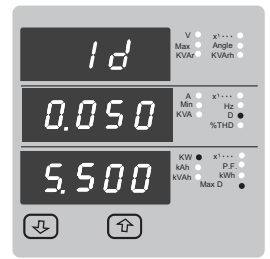

Screen : 4 Ampere Hour

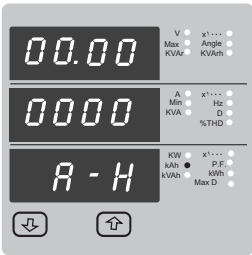

Screen : 5 Min System Voltage & Current

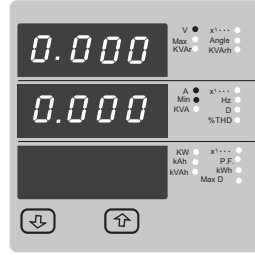

Screen : 6 Export kW Demand/ Max Export kW Demand

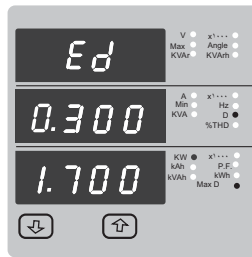

Screen: 7 Run Hour

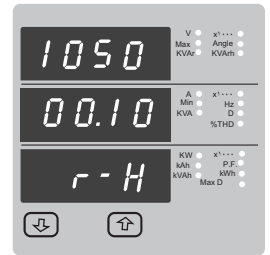

Screen : 8 Max System Voltage & Current

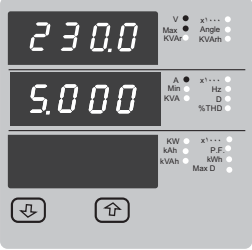

Screen : 9 Current Demand , Max Current Demand

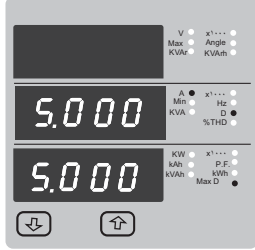

Screen: 10 On Hour

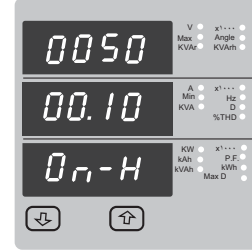

Screen: 11 Number of Interruptions

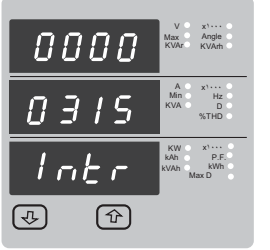

3440 Setup Parameter Screen

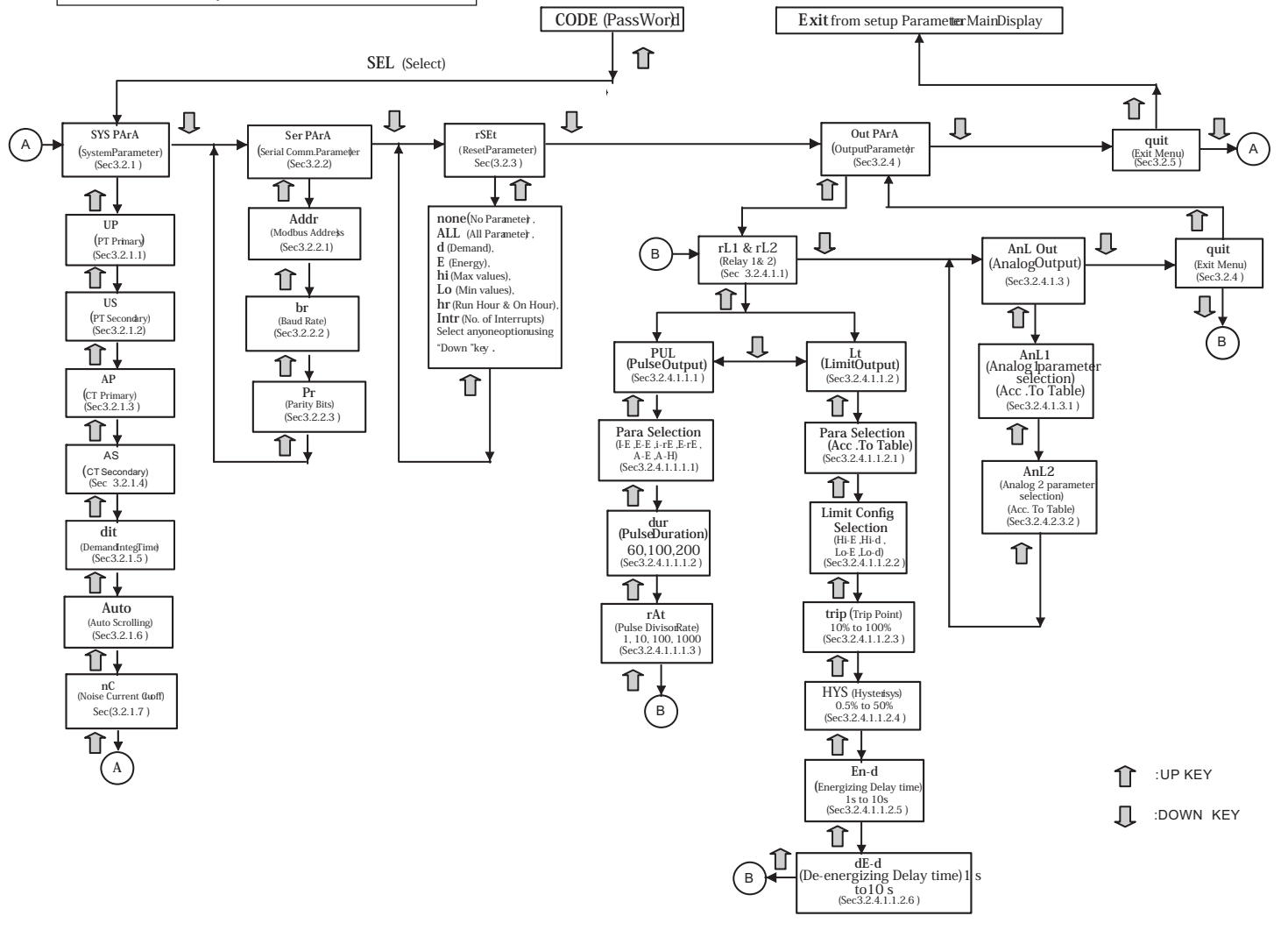

↑ :UP KEY
↓ :DOWN KEY

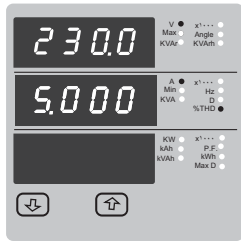

Screen : 11 Voltage & Current% THD

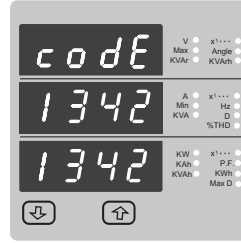

Password confirmed.

Pressing **Down** "key will advance to the" New / change Password "entry stage.

Pressing the **Up** "key will advance to the Menu selection screen.(See section3.2).

3. Programming

The following sections comprise step by step procedures for configuring the 3440 for individual user requirements.

To access the set-up screens press and hold the **Down** and **Up** Key simultaneously for 5 seconds .This will take the User into the Password Protection Entry Stage (Section7.1) .

3.1. Password Protection

Password protection can be enabled to prevent unauthorised access to set-up screens ,by default password protection is not enabled.

Password protection is enabled by selecting a four digit number other than ,... setting a password of ... disables the password protection.

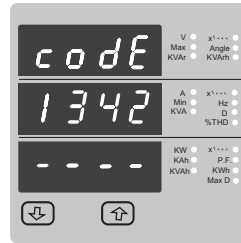

Password Incorrect.

The unit has not accepted the Password entered.

Pressing the **Down** "key will return to the Enter Password stage .

Pressing the **Up** "key exits the Password menu and returns operation to the measurement reading mode.

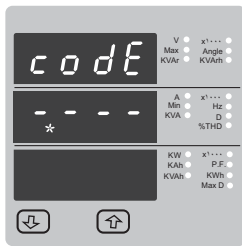

Enter Password, prompt for first digit. (* Denotes that decimal point will be flashing).

Press the **Down** "key to scroll the value of the first digit from 0 through to 9, the value will wrap from 9 round to 0.

Press the **Up** "key to advance to next digit.

In the special case where the Password is "0000" pressing the **Up** "key when prompted for the first digit will advance to the "Password Confirmed" screen.

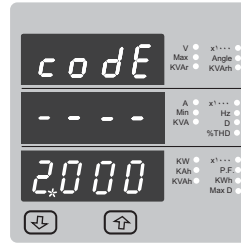

New / Change Password

(*Decimal point indicates that this will be flashing).

Pressing the **Down** "key will scroll the value of the first digit from 0 through to ,9 the value will wrap from 9 round to.0

Pressing the **Up** "key to advance the operation to the next digit and sets the first digit ,in this case to"2"

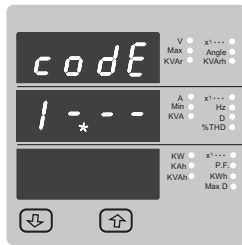

Enter Password, first digit entered, prompt for second digit. (* Denotes that decimal point will be flashing).

Use the **Down** "key to scroll the value of the second digit from 0 through to 9, the value will wrap from 9 round to 0.

Press the **Up** "key to advance to next digit.

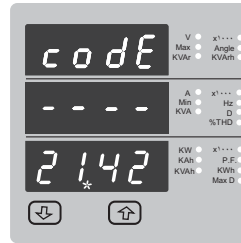

New / Change Password ,first digit entered ,prompting for second digit. (*Denotes that this will be flashing).

Pressing the **Down** "key will scroll the value of the second digit from 0 through to ,9 the value will wrap from 9 round to 0.

Pressing the **Up** "key to advance the operation to the next digit and sets the second digit ,in this case to"1"

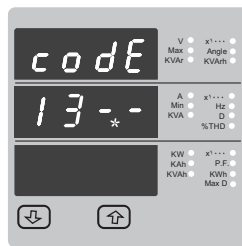

Enter Password ,second digit entered ,prompt for third digit. (*Denotes that decimal point will be flashing).

Use the **Down** "key to scroll the value of the third digit from 0 through to 9 the value will wrap from 9 round to.0

Press the **Up** "key to advance to next digit.

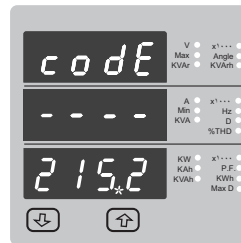

New / Change Password ,second digit entered , prompting for third digit. (*denotes that decimal point will be flashing).

Pressing the **Down** "key will scroll the value of the third digit from 0 through to ,9 the value will wrap from 9 round to.0

Pressing the **Up** "key to advance the operation to the next digit and sets the third digit ,in this case to"5"

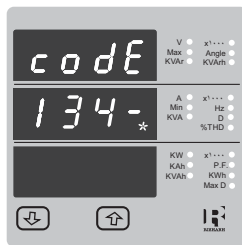

Enter Password ,third digit entered ,prompt for fourth digit. (*Denotes that decimal point will be flashing).

Use the **Down** "key to scroll the value of the fourth digit from 0 through to ,9 the value will wrap from 9 round to.0

Press the **Up** "key to advance to verification of the password.

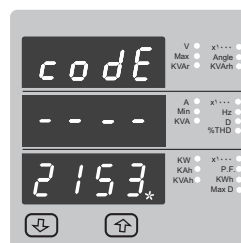

New / Change Password ,third digit entered ,prompting for fourth digit. (*denotes that decimal point will be flashing).

Pressing the **Down** "key will scroll the value of the fourth digit from 0 through to ,9 the value will wrap from 9 round to 0.

Pressing the **Up** "key to advance the operation to the" New Password Confirmed "and sets the fourth digit , in this case to."3"

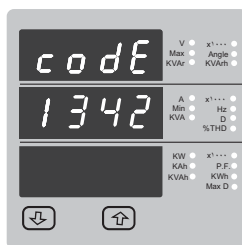

Enter Password ,fourth digit entered ,awaiting verification of the password.

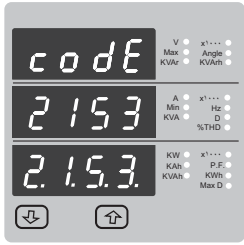

New Password confirmed.

Pressing the **↓** Down "key will return to the "New/Change Password."

Pressing the **↑** Up "key will advances to the Menu selection screen.(see section3.2).

3.2 Menu selection.

3.2.1 System Parameter selection screen.

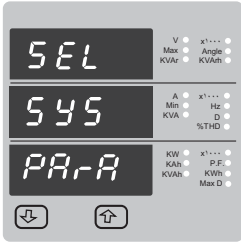

This screen is used to select the different system Parameter like" system type","CT Ratio","PT Ratio ,"

Pressing the **↑** Up "key allows the user to set Different system parameters. (see section 3.2.1.1 to3.2.1.7)

Pressing the **↓** down "key will advance to Communication selection screen (see section 3.2.2)

3.2.2 Communication Parameter selection screen.

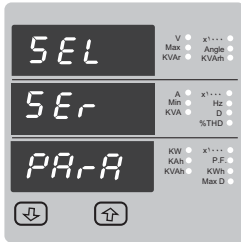

This screen is used to select the different communication parameters like "Address selection", "RS485 Parity selection", "RS485 baud rate"

Pressing the **↑** Up "key allows the user to set different Communication parameters (see section 3.2.2.1 to3.2.2.3)

Pressing the **↓** down key will advance to Reset parameter Screen. (see section 3.2.3)

3.2.3 Reset Parameter selection screen.

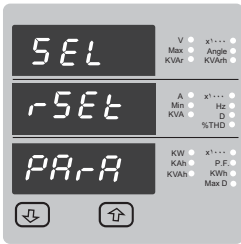

This screen is used to Reset the different parameters.

Pressing the **↑** Up "key allows the user to Reset different system parameters (see section3.2.3.1)

Pressing the **↓** down key " will advance to Output Option selection screen (see section 3.2.4).

3.2.4 Output Option selection screen.

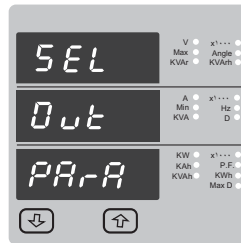

This screen will allow the user to select different Output options Like" Relay","1Relay","2Analog "Output.

Pressing the **↑** Up "key allows the user to select & Configure the output option (see section3.2.4.1)

Pressing the **↓** down key will advance to Quit screen. (see section 3.2.5)

3.2.5 Quit screen.

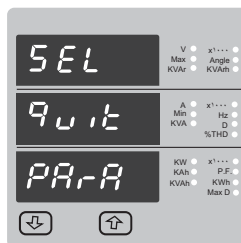

This screen will allow the user to Quit the Menu

Pressing the **↑** Up "key will allow the user to Quit from menu &return to measurement screen.

Pressing the **↓**down key will advance to system Parameter Selection screen (see section 3.2.1)

3.2.1 System parameters Selection

3.2.1.1 Potential Transformer Primary Value

The nominal full scale voltage which will be displayed as Line to Line voltage

This screen allows user to set the primary voltage in kilovolts (note the x 1000enunciator).

Pressing the **↑** Up "key accepts the present value and advances to the" potential Transformer secondary Value edit "menu .(See Section3.2.1.2).

Pressing the **↓** Down "key will enter the" Potential Transformer Primary Value Edit "mode.

Initially the" multiplier must be selected ,pressing the **↓**Down "key will move the decimal point position to the right until it reaches # . # # # after which it will return to # . # # #.

Pressing the **↑** Up "key accepts the present Multiplier (decimal point position) and advances to the "potential Transformer primary Digit Edit "mode.

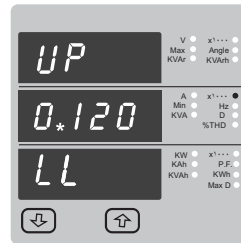
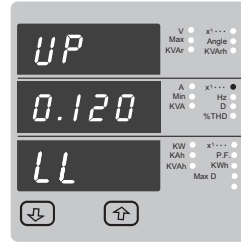

Potential Transformer primary Digit Edit

Pressing the **↓** Down "key will scroll the value of the most significant digit from 0 through to 9 unless the presently displayed Potential Transformer Primary Value together with the Current Transformer Primary Value ,previously set ,would result in a maximum power of greater than 666.6 MVA in which case the digit range will be restricted.

Pressing the **↑** Up "key accepts the present value at the cursor position and advances the cursor to the next less significant digit.

The PT Primary value can be set from100 V L-L to692.8 KV L-L.

Note : the flashing decimal point indicates the cursor position ,a steady decimal point will be present to identify the scaling of the number until the cursor position coincides with the steady decimal point position .At this stage the decimal point will flash.

When the least significant digit has been set pressing the **↑** Up "key will advance to the "Potential Transformer Primary Value Confirmation "stage.

Screen showing display of 0.120 kV i.e 120V .Volts indicating steady decimal point and cursor flashing at the" hundreds of volts "position.

Potential Transformer Primary Value Confirmation

This screen will only appear following an edit of the Potential Transformer Primary Value.

If the scaling is not correct ,pressing the **↓** Down " key will return to the" Potential Transformer Primary Value Edit "stage.

Pressing the **↑** Up "key sets the displayed value and will advance to the Potential Transformer secondary Value (See Section3.2.1.2)

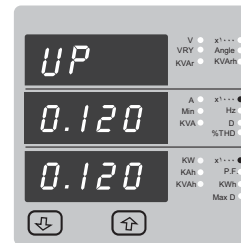

0.120kV i.e 120V L-L

3.2.1.2 Potential Transformer secondary V alue

The value must be set to the nominal full scale secondary voltage which will be obtained from the Transformer when the potential transformer(PT)primary is supplied with the voltage defined in3.2.1.1 potential transformer primary voltage.The ratio of full scale primary to full scale secondary is defined as the transformer ratio.

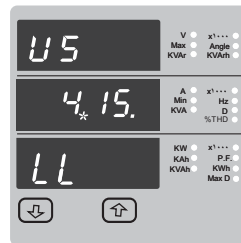

Pressing the **↑** Up "key accepts the present value and advances to the" Current Transformer Primary Value edit "menu .(See Section3.2.1.3)

Note that the range of instrument is from 240 to480 V for 415 V L-L. Please refer the table below for different ranges.

Pressing the **↓** Down "key will enter the" Potential Transformer Secondary Value Edit "mode.

"↓Down" key will scroll the value of the most significant digit from available range of PT secondary value

Pressing the **↑** Up "key accepts the present value at the cursor position and advances the cursor to the next less significant digit.

Potential Transformer secondary ranges for various Input V oltagess

110V L-L (63.5V L-N)	100 - 120V L-L (57.73V - 69.28V L-N)
230V L-L (133.0 V L-N)	121 - 239V L-L (69.86V - 138V L-N)
415V L-L (239.6V L-N)	240 - 480V L-L (138.56V - 277.12V L-N)

Note : the flashing decimal point indicates the cursor position ,a steady decimal point will be present to identify the scaling of the number until the cursor position coincides with the steady decimal point position .At this stage the decimal point will flash.

When the least significant digit has been set pressing the **↑** Up "key will advance to the "Potential Transformer secondary Value Confirmation "stage.



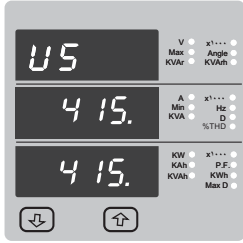

Potential Transformer Secondary Value Confirmation

This screen will only appear following an edit of the Potential Transformer Secondary Value.

If the scaling is not correct ,pressing the **Down** key will return to the " Potential Transformer Secondary Value Edit"

Pressing the **Up** key sets the displayed value and will advance to the current Transformer Primary Value (See Section3.2.1.3)

3.2.1.5 Demand Integration Time

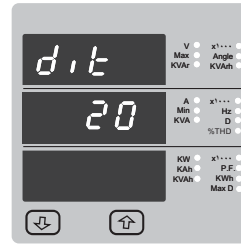

This screen is used to set the period over which current and power readings are to be integrated The Unit of displayed Readings is minutes.

Pressing the **Down** key will scroll through the following Options 8,15,20,30.

Pressing the **Up** key will advance to Demand Integration confirmation screen.

3.2.1.3 Current Transformer Primary Value

The nominal Full Scale Current that will be displayed as the Line currents .This screen enables the user to display the Line currents inclusive of any transformer ratios ,the values displayed represent the Current in Amps.

Pressing the **Up** key accepts the present value and advances to the Current Transformer Secondary Value (See Section3.2.1.4)

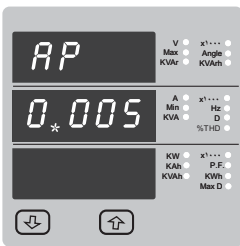

Pressing the **Down** key will enter the " Current Transformer Primary Value Edit "mode .This will scroll The value of the most significant digit from 0 through to ,9 unless the presently displayed Current Transformer Primary Value together with the Potential Transformer Primary Value results in a maximum power of greater than 666.6 MVA in which case the digit range will be restricted ,the value will wrap .Example :if primary value of PT is set as692.8 kVL-L (max value) then primary value of Current is restricted to1157 A.

Pressing the **Up** key will advance to the next less significant digit .(*Denotes that decimal point will be flashing).

The " Maximum Power "restriction of 666.6 MVA refers to 120% of nominal current and 120% of nominal voltage ,i.e 462.96 ,MVA nominal power.

When the least significant digit had been set ,pressing the **Up** key will advance to the "Current Transformer Primary Value Confirmation "stage.

The minimum value allowed is ,1 the value will be forced to 1 if the display contains zero when the **Up** key is pressed.

Current Transformer Primary Value Confirmation.

This screen will only appear following an edit of the Current Transformer Primary Value.

If the scaling is not correct ,Pressing the **Down** key will return to the " Current Transformer Primary Value Edit" stage with the most significant digit highlighted (associated decimal point flashing) and the bottom line of the display will be blanked.

Pressing the **Up** key sets the displayed value and will advance to the " Current Transformer Secondary Value Edit "menu .(See Section3.2.1.4)

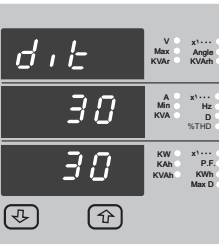

Demand Integration Time value confirmation

Pressing **Up** key sets the displayed value and will advance to scroll screen. (See Section3.2.1.6)

3.2.1.6 Auto Scrolling :

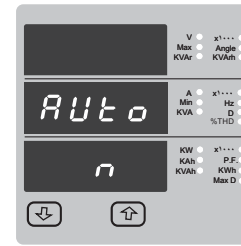

This screen allows user to enable screen scrolling. Auto scrolling Edit.

Pressing **Up** key accepts the present status and advance to the Low Current noise cutoff. (See Section 3.2.1.7).

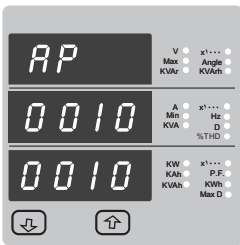

This screen will only appear following an edit of the Current Transformer Primary Value.

If the scaling is not correct ,Pressing the **Down** key will return to the " Current Transformer Primary Value Edit" stage with the most significant digit highlighted (associated decimal point flashing) and the bottom line of the display will be blanked.

Pressing the **Up** key sets the displayed value and will advance to the " Current Transformer Secondary Value Edit "menu .(See Section3.2.1.4)

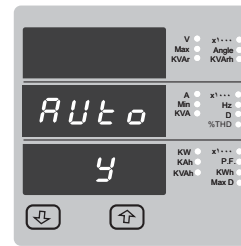

Pressing the **Down** key will enter the " Auto Screen Scrolling Edit "and toggle the status 'Yes 'and' No.'

Pressing the **Up** key will select the status displayed and advance to the Low Current noise cutoff. (See Section 3.2.1.7).

3.2.1.4 Current Transformer Secondary Value

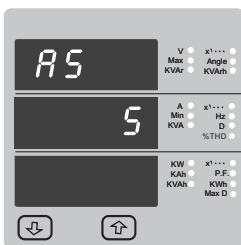

This screen is used to set the secondary value for Current Transformer .Secondary value "5" for5 A or "1"for1 A can be selected .Pressing **Up** key accepts the present value and advances to the Demand integration Time (See Section3.2.1.5)

Pressing the **Down** key will enter the CT Secondary value edit mode and scroll the value through the values available.

Pressing the **Up** key will advance to the CT Secondary value confirmation.

3.2.1.7 Low Current noise cutoff.

This screen allows the user to set Low noise current cutoff in mA.

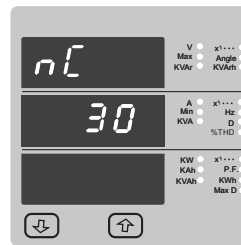

Low current cutoff Edit.

Pressing **Up** key accepts the present value and advance to System Parameter Selection. (See section3.2.1)

Pressing the **Down** key will enter the " Low current noise cutoff Edit "mode and scroll the " Value "through30 & 0 and wrapping back to .0 Setting 30 will display measured currents as 0 below 30 mA.

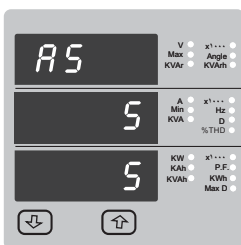

CT Secondary value confirmation

This screen will only appears following an edit of CT secondary value.

If secondary value shown is not correct ,pressing the Down key will return to CT secondary edit stage by blanking the bottom line of the display.

Pressing **Up** key sets the displayed value and will advance to Demand integration Time Edit menu. (See Section3.2.1.5)

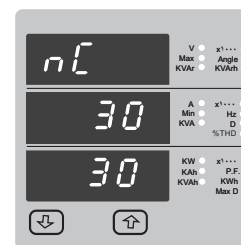

Low current noise cutoff Confirmation.

pressing the **Down** key will re-enter the " Low current Noise cutoff Edit "mode.

Pressing **Up** key set displayed value and will jump back to the system parameter selection (See section3.2.1)

3.2.2 Communication Parameter Selection :

3.2.2.1 Address Setting : This screen applies to the RS 485 output only . This screen allows the user to set RS 485 parameter for instruments

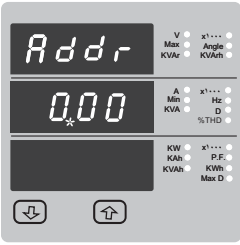

The range of allowable address is 1 to 255

Enter Address ,prompt for first digit.
(*Denotes that decimal point will be flashing).

Press the **Down** key to scroll the value of the first digit

Press the **Up** key to advance to next digit.

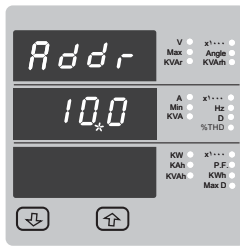

Enter Address ,first digit entered ,prompt for second digit
(*Denotes that decimal point will be flashing).

Use the **Down** key to scroll the value of the second digit

Press the **Up** key to advance to next digit.

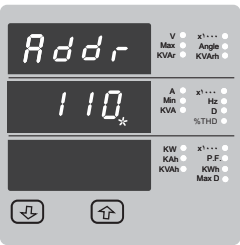

Enter Address ,second digit entered ,prompt for third digit
(*Denotes that decimal point will be flashing).

Use the **Down** key to scroll the value of the third digit

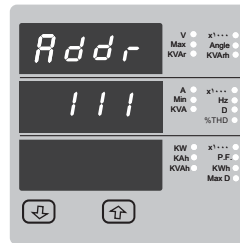

Enter Address for third digit.

Press the **Up** key to advance to Address confirmation Screen.

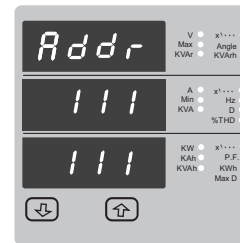

Address confirmation Screen.

This Screen confirms the Address set by user.

Press the **Up** key to advance to next Screen
"RS485 Baud Rate" (See Section 3.2.2.2)

Pressing the **Down** key will reenter the" Address Edit "mode.

3.2.2.2 RS 485 Baud Rate :

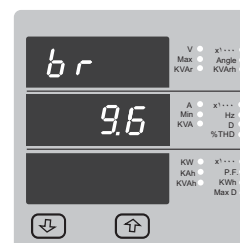

This screen allows the user to set Baud Rate of RS 485 port.
The values displayed on screen are in kbaud.

Pressing **Up** key accepts the present value and advance to the Parity Selection (See Section 3.2.2.3).

Pressing the **Down** key will enter the" Baud Rate Edit "mode and scroll the value through 19.2 ,9.6 ,4.8 ,2.4 and back to 2.4

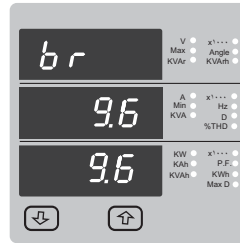

3.2.2.3 RS 485 Parity Selection :

This screen allows the user to set Parity & number of stop bits of RS 485 port .

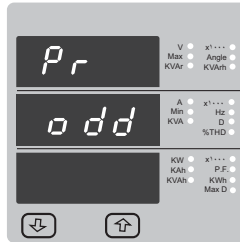

Pressing **Up** key accepts the present value and advance to Menu selection (see section 3.2.2).

Pressing the **Down** key will enter the" Parity & stop bit Edit "mode and scroll the value through

odd : odd parity with one stop bit
no : 1 no parity with one stop bit
no : 2 no parity with two stop bit
E : even parity with one stop bit

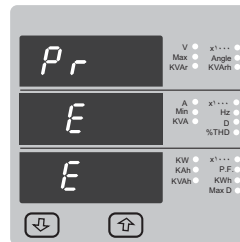

RS 485 Parity confirmation:

Pressing **Down** key will be re-enter into Parity Edit mode.

Pressing the **Up** key will set the value .

Pressing the **Up** key again will jump back to the communication parameter selection menu (see section 3.2.2).

3.2.3 Reset Parameter Selection :

3.2.3.1 Resetting Parameter

The following screens allow the users to reset the all Energy , Lo(Min) ,hi(Max),Demand,Run hour , On hour ,No.of Interrupts

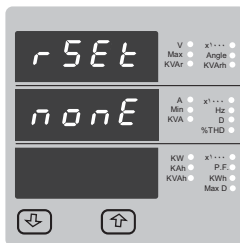

Reset (None)

Pressing **Up** key advances to Reset Parameter selection screen (see section 3.2.3)

Pressing the **Down** key will enter the" Reset option "mode and scroll through Parameter and wrapping back to None.

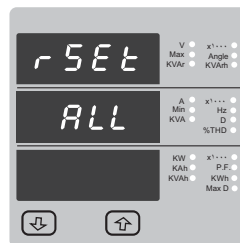

Reset option select ,(Resets ALL resettable parameter)

The user has scrolled through to the" ALL. "

Pressing **Up** key will select the value & advance to the "Reset ALL Confirmation" Mode & will reset all resettable parameter.

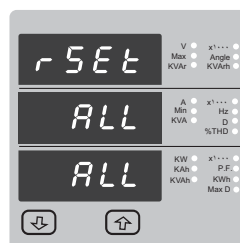

Reset ALL Confirmation.

Pressing the **Down** key will re-enter the reset option Select mode.

Pressing **Up** key will jump back to the reset parameter selection screen (see section 3.2.3).

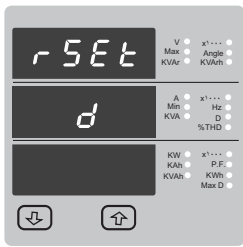

Reset option select ,(Reset A Demand ,KVA Demand Parameters KW demand (Import/Export))

The user has scrolled through to the "d."

Pressing **↑Up** "key will select the value and resets all Demand parameters .

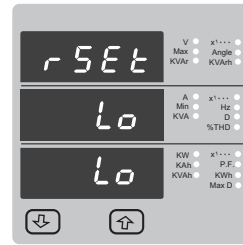

Reset Lo Confirmation

Pressing the **↓Down** "key will re-enter the "Reset option Select mode.

Pressing **↑Up** "key will jump back to the Reset Parameter selection screen (see section3.2.3).

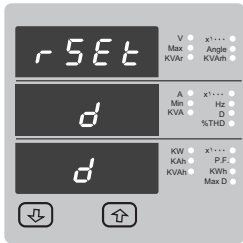

Reset Demand parameters Confirmation.

Pressing the **↓Down** "key will re-enter the "Reset option Select mode.

Pressing **↑Up** "key will jump back to the Reset Parameter selection screen (see section3.2.3).

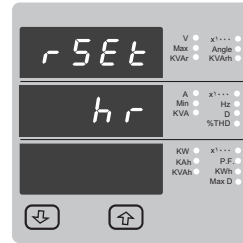

Reset option select ,hr (ON Hour & Run Hour)

The user has scrolled through to the "hr "

Pressing **↑Up** "key will select the value and advance to the" Reset hr Confirmation "Mode& Will reset On hour & Run Hour both .

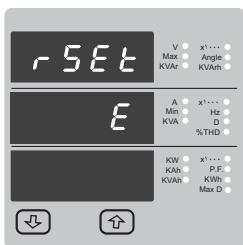

Reset option select ,(Resets all Energies)

The user has scrolled through to the "E "Energy value.

Pressing **↑Up** "key will select the value and advance to the" Reset Energy Confirmation "Mode &resets all Energies (Import Energy ,Export Energy Import reactive ,Export reactive ,Apparent Energy Ampere Hour)

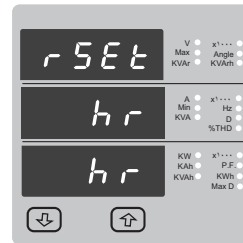

Reset hr Confirmation

Pressing the **↓Down** "key will re-enter the "Reset option Select mode.

Pressing **↑Up** "key will jump back to the Reset Parameter selection screen (see section3.2.3).

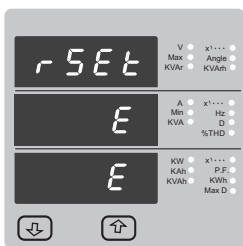

Reset Energy Confirmation.

Pressing the **↓Down** "key will re-enter the" Reset option "mode.

Pressing **↑Up** "key will jump back to the Reset Parameter selection screen (see section3.2.3).

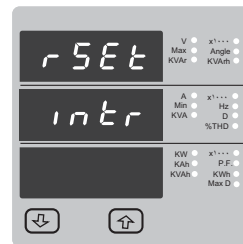

Reset option select ,(Reset Number of Interrupt)

The user has scrolled through to the "intr"

Pressing **↑Up** "key will select the value and advance to the" reset Interrupt Confirmation "Mode& Will reset number of Auxiliary supply interruption count .

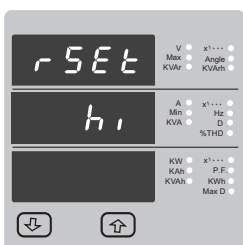

Reset option select ,(Reset Hi)

The user has scrolled through to the "Hi "(Max)

Pressing **↑Up** "key will select the value and advance to the" Reset Hi Confirmation "Mode & will Reset Maximum (Hi) values of Voltage & Current Avg .Appeared at input.

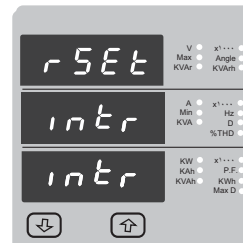

Reset Interrupt Confirmation

Pressing the **↓Down** "key will re-enter the "Reset parameter Selection"(see section3.2.3).

Pressing **↑Up** "key will jump back to the Reset Parameter selection screen (see section3.2.3).

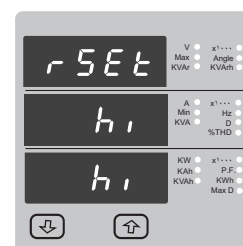

Reset hi (Max) Confirmation.

Pressing the **↓Down** "key will re-enter the "Reset option Select mode.

Pressing **↑Up** "key will jump back to the Reset Parameter selection screen (see section3.2.3).

3.2.4. Output Option selection menu

3.2.4.1 Configuration of Output

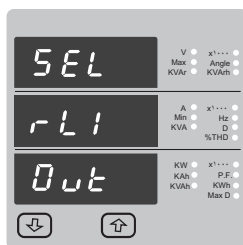

This screen applies to the Relay 1Output option Selection .

Pressing **↑Up** "key will select the

Relay 1output selection menu(See section3.2.4.1.1)

pressing the **↓Down** "key will advance

Relay 2output option below.

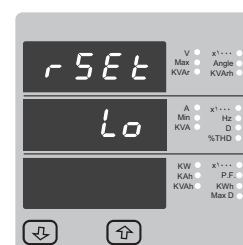

Reset option select ,(Reset Lo)

The user has scrolled through to the" Lo "(Min)

Pressing **↑Up** "key will select the value and advance to the" Reset Lo Confirmation "Mode & will reset minimum values of Voltage & Current Avg . appeared at Input.

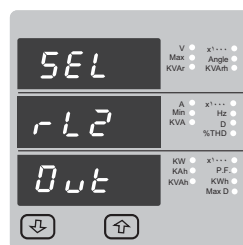

This screen applies to the Relay 2Output option Selection .

Pressing **↑Up** "key will advance to the select

Relay 2 output selection menu. (See section3.2.4.1.2)

pressing the **↓Down** "key will advance to Analog output option below.



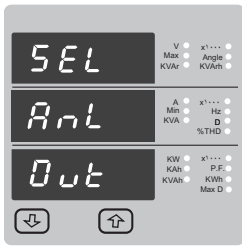

This screen applies to the Analog Output Selection.

Pressing **↑**Up "key will Select the Analog output selection menu (See section3.2.4.3)

Pressing the **↓**Down "key will advance to Quit screen.

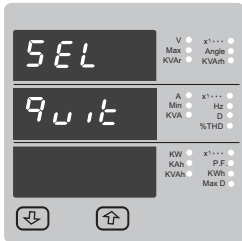

This screen allows the user to quit the output option

Pressing **↑**Up "key will advance to the Output Parameter selection (See section3.2.4)

Pressing the **↓**Down "key will go back to Relay 1output option (See section3.2.4.1).

3.2.4.1.1 Relay1 output Selection menu :

3.2.4.1.1.1 Pulse output :

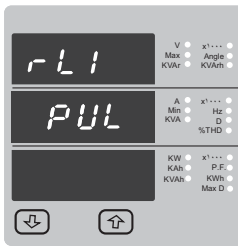

This screen is used to assign Relay 1in Pulse output mode

Pressing **↑**Up "key will advance to the Pulse (for Relay1) output configuration (See section3.2.4.1.1.1.1)

Pressing **↓**Down "key will show "Limit"output option (See section3.2.4.1.1.2)

3.2.4.1.1.2 Limit output :

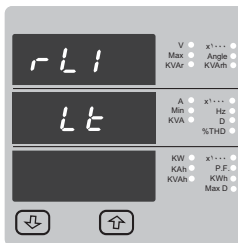

This screen is used to assign Relay 1in limit output mode.

Pressing **↑**Up "key will assign Limit (for Relay1) output mode(See section3.2.4.1.1.2.1)

Pressing **↓**Down "key will go back to the pulse option (For Relay1) screen.(See section3.2.4.1.1.1)

3.2.4.1.1.1.1 Assignment of Energy to pulse output (Relay 1) :

This screen allows the user to assign pulse output to energy (for Relay1)

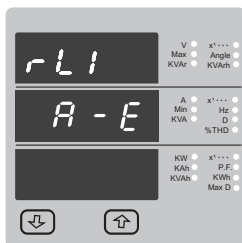

Pressing **↑**Up "key accepts the present setting and advance to" Pulse duration selection" (see section3.2.4.1.1.1.2).

Pressing the **↓**Down "key will enter into edit mode and scroll through the energy setting

A - E : Apparent Energy
I - E : Import Energy (Active)
E - E : Export Energy (Active)
I - rE : Import Reactive Energy
E - rE : Export Reactive Energy
A - H : Ampere Hour

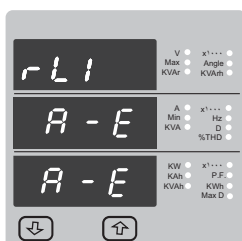

Pulse output (for Relay1) confirmation:

Pressing **↓**Down "key will be re-enter into edit mode.

Pressing the **↑**Up "key will set the value and advances to the " Pulse duration selection" (see section3.2.4.1.1.1.2).

3.2.4.1.1.1.2 Pulse Duration Selection:

This screen applies only to the Pulsed output mode of both the relay
 This screen allows the user to set Relay energisation time in milliseconds.

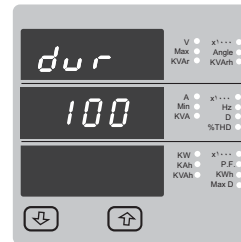

Pulse Duration Edit.

Pressing **↑**Up "key accepts the present value and advance to pulse rate selection menu (see section.3.2.4.1.1.1.3)

Pressing the **↓**Down "key will enter the" Pulse Duration Edit "mode and scroll the value through 200 ,100 ,60 and wrapping back to.60

Pressing the **↑**Up "key will select the value and advances to " Pulse Duration Confirmation."

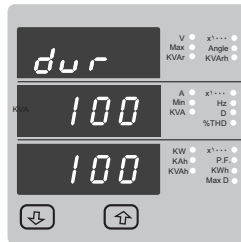

Pulse Duration Confirmation.

This screen will only appear following an edit of the Pulse duration.

pressing the **↓**Down "key will re-enter the" Pulse Duration Edit "mode.

Pressing **↑**Up "key set displayed value and Will advance to pulse rate selection menu (See section3.2.4.1.1.1.3)

3.2.4.1.1.1.3 Pulse Rate

This screen applies to the Relay Output option only .The screen allows user to set the energy pulse rate divisor .Divisor values can be selected through.1,10,100,1000

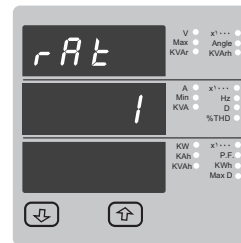

Pressing **↑**Up "key accepts the presents value and advances to the" Configuration of Output " (See section3.2.4.1).

Pressing the **↓**Down "key will enter the" Pulse rate divisor edit "mode and scroll the values through the values 1,10,100,1000 wrapping back to.1

Pressing the **↑**Up "key advances to the" Pulse rate Divisor Confirmation "menu.

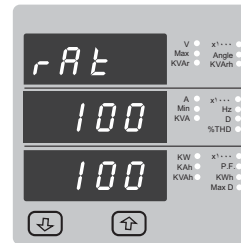

Pulse Rate Divisor Confirmation.

This screen will only appear following an edit of the Pulse rate divisor.

If the Pulse rate shown is not correct ,pressing the **↓**Down "key will return to the" Pulse rate divisor Edit "stage by blanking the bottom line of the display.

Pressing **↑**Up "key sets the displayed value and will advance to the" Configuration of output." (See section3.2.4.1)

3.2.4.1.1.2.1 Assignment of Limit output (for Relay1) to parameter

This screen is for Limit output mode selection .It allows the user to set Limit output corresponding measured value . Refer Table 2" Parameter for Analog & Limit output " for assignment.

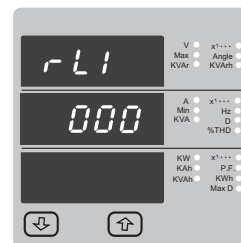

Pressing **↑**Up "key accepts the present value and advance to the Limit 1configuration select screen. (see section 3.2.4.1.1.2.2).

Pressing the **↓**Down "key will enter the " Limit 1output Edit " mode and scroll the values ,as per Table,2 "Parameter for Analog & Limit Output"

Pressing the **↑**Up "key advance to the Limit 1output confirmation screen.

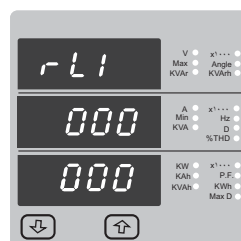

Limit 1output Confirmation:

Pressing the **↓**Down "key will re-enter the " Limit 1 output Edit "

Pressing the **↑**Up "key sets the displayed value and will advance to the Limit 1Configuration select screen (see section 3.2.4.1.1.2.2)

3.2.4.1.1.2.2 Limit1 Configuration select

This screen is used to set the Limit 1 Configuration, four different types of configuration can be selected

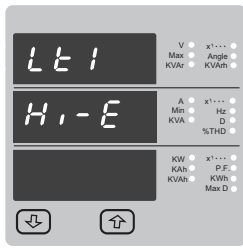

- H i - E (High Alarm & Energized Relay)
 - H i - d (High Alarm & De-Energized Relay)
 - L o - E (Low Alarm & Energized Relay)
 - L o - d (Low Alarm & De-Energized Relay)
- (For detail refer to section 9.2)

Pressing the **Up** key accepts the present value and advances to the "Trip point selection" screen (see section 3.2.4.1.1.2.3)

Pressing the **Down** key will enter the Limit 1 configuration edit mode and scroll through the Modes available.

Pressing the **Up** key advances to the Limit 1 configuration type confirmation menu.

Limit 1 Configuration Confirmation

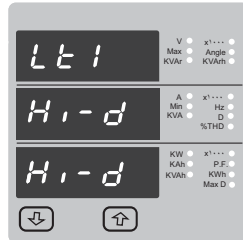

This screen will only appear following the edit of system type. If system type is to be changed again,

pressing the **Down** key will return to the Limit 1 configuration Type edit stage by blanking the bottom line of the display

Pressing the **Up** key sets the displayed value and will advance to "Trip point selection" screen (See section 3.2.4.1.1.2.3)

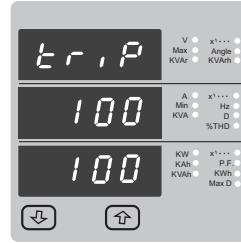

Value confirmation Screen.

This Screen confirms the value set by user.

Press the **Up** key to advance to next Screen

"Hysteresis selection" (see section 3.2.4.1.1.2.4)

Pressing the **Down** key will return in edit mode

3.2.4.1.1.2.4 Hysteresis selection :

This screen applies to the Hysteresis selection .

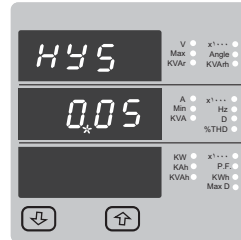

This screen allows the user to set Hysteresis for relay 1 output

The allowable range is 0.1% to 10% of Trip point.

Enter value ,prompt for first digit. (*Denotes that decimal point will be flashing).

Press the **Down** key to scroll the value of the first digit

Press the **Up** key to advance to next digit.

3.2.4.1.1.2.3 Trip point selection :

This screen applies to the Trip point selection .

This screen allows the user to set Trip point for instruments

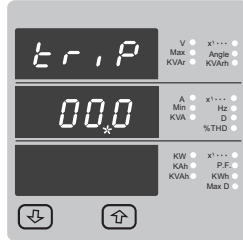

The allowable range is 10% to 110% for High Alarm. The allowable range is 10% to 110% for Low Alarm.

Enter value ,prompt for first digit. (*Denotes that decimal point will be flashing).

Press the **Down** key to scroll the values of the first digit

Press the **Up** key to advance to next digit.

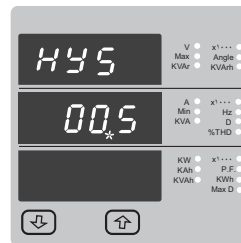

The first digit entered ,prompt for second digit (*Denotes that decimal point will be flashing).

Use the **Down** key to scroll the value of the second digit

Press the **Up** key to advance to next digit.

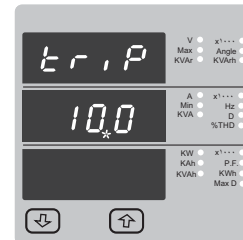

The first digit entered ,prompt for second digit (*Denotes that decimal point will be flashing).

Use the **Down** key to scroll the value of the second digit

Press the **Up** key to advance to next digit.

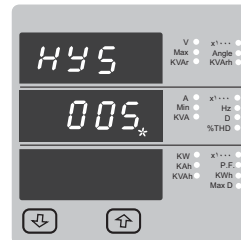

The second digit entered ,prompt for third digit (*Denotes that decimal point will be flashing).

Use the **Down** key to scroll the value of the third digit

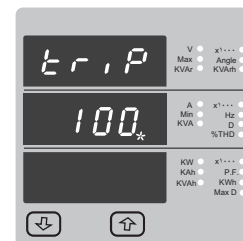

The second digit entered ,prompt for third digit (*Denotes that decimal point will be flashing).

Use the **Down** key to scroll the value of the third digit

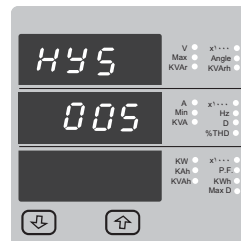

Entered value for third digit.

Press the **Up** key to advance to Hysteresis confirmation Screen.

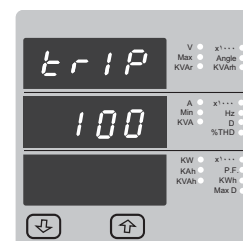

Entered the value for third digit.

Press the **Up** key to advance to trip point confirmation Screen.

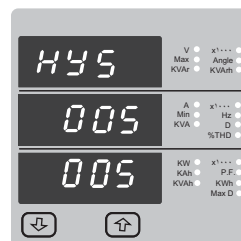

Hysteresis confirmation Screen.

This Screen confirms the percentage value set by user. &Screen will appear only after edit mode of Hysteresis.

Press the **Up** key to advance to next Screen

"Energizing delay time" (3.2.4.1.1.2.5)

3.2.4.1.1.2.5 Energizing Delay time.

This screen allows the user to set Energizing Delay time for Relay 1 Limit Assigned Parameters.

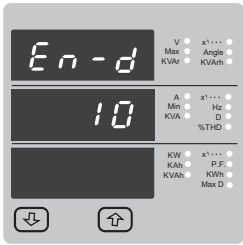

Pressing **↑**Up "key accepts the present value and advance to De-energizing delay screen

Pressing the **↓**Down "key will enter the "Energizing Delay "Edit mode and scroll the " Value "through 1 to 10

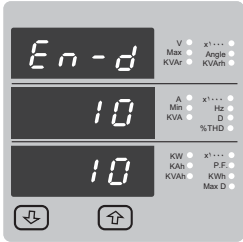

Energizing delay time Confirmation.

This screen will appear only after edit mode of Energizing delay time

pressing the **↓**Down "key will re-enter the" Energizing delay Edit "mode.

Pressing **↑**Up "key set displayed value and will advance to Assignment of De-energizing delay time . (See section 3.2.4.1.1.2.6)

3.2.4.1.1.2.6 De-Energizing Delay time.

This screen allows the user to set De-Energizing Delay time for Relay 1 Limit Assigned Parameters.

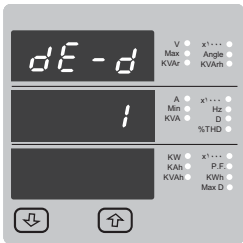

Pressing **↑**Up "key accepts the present value and advance to Configuration of Output. (See section 3.2.4.1)

Pressing the **↓**Down "key will enter the "De-Energizing Delay" Edit mode and scroll the " Value "through 1 to 10

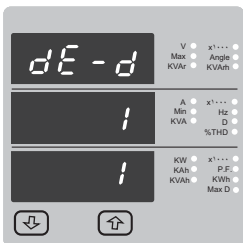

De-Energizing delay time Confirmation.

This screen will appear only after edit mode of De-energizing delay time.

pressing the **↓**Down "key will re-enter the "De-energizing delay Edit "mode.

Pressing **↑**Up "key set displayed value and will advance to Configuration of Output . (See section 3.2.4.1)

3.2.4.1.2 Relay 2 Output Selection :

Configuration of Relay 2 for Pulse or Limit Output is same as Relay .1 If you Select the Pulse output option for Relay 1 same setting will be applicable for Relay 2 except assignment of energy to Pulse output (i.e .Energy assignment of both relay can be different.)

3.2.4.1.3 Analog Output

3.2.4.1.3.1 Parameter setting for Analog Output 1 (Optional)

This screen is for analog output 1 only .It allows the user to set analog output 1 to corresponding measured parameter . Refer table " 2Parameter for Analog & Limit output."



Pressing **↑**Up "key accepts the present value and advance to the Analog output 2 selection (see section 3.2.4.1.3.2)

Pressing the **↓**Down "key will enter the " Analog output 1 Edit " mode and scroll the values ,as per Table 2 "Parameter for Analog & Limit output"

Pressing the **↑**Up "key advance to the Analog output 1 confirmation screen.

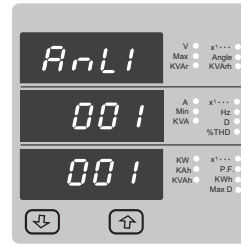

Analog output 1 Confirmation

This Screen will appear only after edit mode of Analog output 1 Parameter.

Pressing the **↓**Down "key will re-enter the " Analog output 1 Edit "

Pressing the **↑**Up "key sets the displayed value and will advance to the Analog output 2 selection screen (see section 3.2.4.1.3.2)

3.2.4.1.3.2 Parameter setting Analog Output 2 (Optional)

This screen is for analog output 2 only .It allows the user to set analog output 2 to corresponding measured parameter . Refer table " 2Parameter for Analog & Limit output."

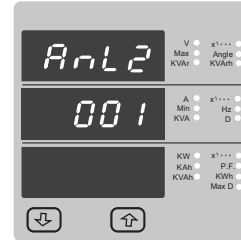

Pressing **↑**Up "key accepts the present value and advance to Analog output selection screen (see section 3.2.4.1)

Pressing the **↓**Down "key will enter the " Analog output 2 Edit "mode and scroll the values ,as per Table ".2 Parameter for Analog output"

Pressing the **↑**Up "key advance to the Analog output 2 confirmation screen.

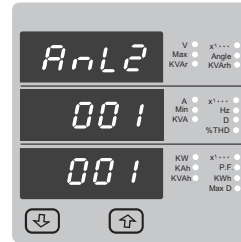

Analog output 2 Confirmation:

This Screen will appear only after edit mode of Analog output 2 Parameter.

Pressing the **↓**Down "key will re-enter the " Analog output 2 Edit "

Pressing the **↑**Up "key sets the displayed value and will advance to the Analog output selection screen (see section 3.2.4.1)

4. Run Hour

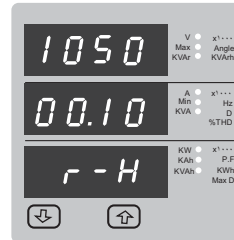

This Screen shows the total no .of hours the load is connected Even if the Auxiliary supply is interrupted count of Run hour will be maintained in internal memory & displayed in the format " hours .Min ."

For example if Displayed count is 105000.10 r-H it indicates 105000 hours & 10 minutes.

After 999999.59 run hours display will restart from zero.

To reset run hour manually see section Resetting Parameter 3.2.3.1

5. On Hour

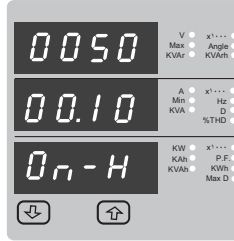

This Screen shows the total no .of hours the Axillary Supply is ON .Even if the Auxiliary supply is interrupted count of the On hour will be maintained in internal memory & displayed in the format" hours .min."

For example if Displayed count is 005000.10 On-H it indicates 005000 hours & 10 minutes.

After 999999.59 On hours display will restart from zero.

To reset On hour manually see section Resetting Parameter 3.2.3.1

6. Number of Interruption :

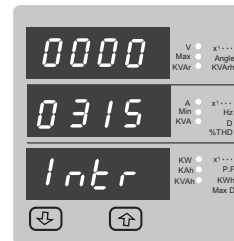

This Screen Displays the total no .of times the Axillary Supply was Interrupted .Even if the Auxiliary supply is interrupted count will be maintained in internal memory To reset No of Interruption manually see section Resetting Parameter 3.2.3.1

7. Analog Output (optional) :

This module provides two d.c. isolated outputs. There are two output options

- 1) Two 0 - 1mA outputs , internally powered .
- 2) Two 4 - 20mA outputs , internally powered .

The 1- 0 mA output module has an 0 V return on each end of the 4 way connector (Please refer section 14 for connection details)

On both modules the output signals are present on pins A1(Analog Output1) & A2 (Analog Output 2)

These outputs can be individually assigned to represent any one of the measured and displayed Parameters.

All settings are user configurable via the user interface screen . See Analog o/p selection (section 3.2.4.1.3) for details .

*Note : Refer diagrams & \

Diagram : 1 (20- 4 mA)

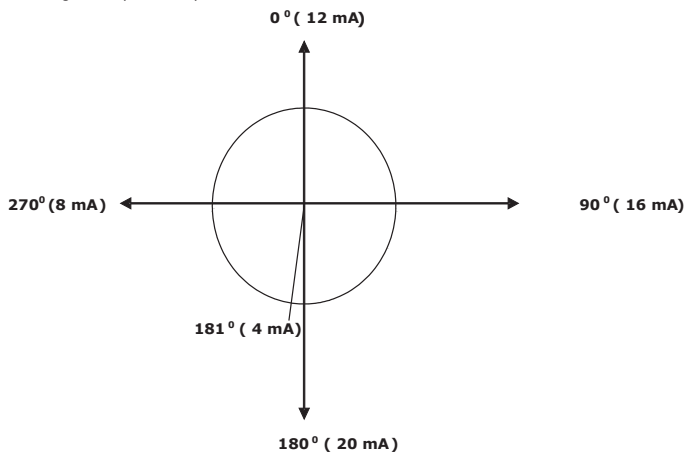
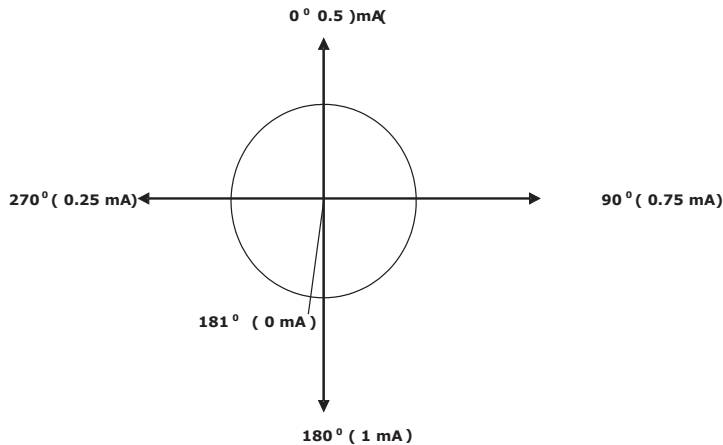

Diagram : 2 (1- 0 mA)



7. Analog Output (optional) :

TABLE : Ƴ Parameter for Analog & Limit output

Parameter No.	Parameter	Range
0	None	—
1	System Volts	0 - 100 %
4	System IL	0 - 100 %
7	System W	0 - 120 %
10	System VA	0 - 120 %
13	System Var	0 - 120 %
16	*PF	180 / 0 / -180
19	*PA	180 / 0 / -180
36	Freq.	45 to 66 Hz
43	Watt Demand Imp.	0 - 120 %
44	Watt Max Demand Imp.	0 - 120 %
45	Watt Demand Exp	0 - 120 %
46	Watt Demand Max Exp	0 - 120 %
51	VA Demand	0 - 120 %
52	VA Max Demand.	0 - 120 %
53	Current Demand.	0 - 100 %
54	Current Max Demand.	0 - 100 %

8. Relay output (Optional) :

3440 is provided with either 1 or 2 relay for pulse output as well as for limit switch

8.1 Pulse Output :

Pulse output is the potential free ,very fast acting relay contact which can be used to drive an external mechanical counter for energy measurement.

3440 pulse output can be configured to any of the following parameter through setup parameter screen

- 1) Active Energy (Import)
- 2) Active Energy (Export)
- 3) Reactive Energy (Import)
- 4) Reactive Energy (Export)
- 5) Apparent Energy
- 6) Ampere hour

TABLE : Ƴ Energy Pulse Rate Divisor

Divisor	Pulse rate	
	Pulse	System Power*
1	1per Whr	Up to3600 W
	1per kWhr	Up to3600 kW
	1per MWhr	Above3600 kW
10	1per 10Whr	Up to3600 W
	1per 10kWhr	Up to3600 kW
	1per 10MWhr	Above3600 kW
100	1per 100Whr	Up to3600 W
	1per 100kWhr	Up to3600 kW
	1per 100MWhr	Above3600 kW
1000	1 per 1000Whr	Up to3600 W
	1 per 1000kWhr	Up to3600 kW
	1per 1000MWhr	Above3600 kW

Pulse Duration 60 ms 100,ms or 200 ms

Above options are also applicable for Apparent and Reactive Energy.

*System power = CT(Primary) x PT(Primary)

Ampere Hour:

Divisor1 (Default)

CT secondary1 = A Max pulse rate 3600 pulses per Ah**

CT secondary5 = A Max pulse rate 720 pulses per Ah**

Divisors10

CT secondary1 = A Max pulse rate 3600 pulses per10 Ah**

CT secondary5 = A Max pulse rate 720 pulses per10 Ah**

Divisors100

CT secondary1 = A Max pulse rate 3600 pulses per100 Ah**

CT secondary5 = A Max pulse rate 720 pulses per100 Ah**

Divisors1000

CT secondary1 = A Max pulse rate 3600 pulses per1000 Ah**

CT secondary5 = A Max pulse rate 720 pulses per1000 Ah**

Pulse duration 60 ms 100, ms or 200 ms

**No. of Pulses per Ampere hour = Maximum Pulses / CT Ratio

Where ,CT Ratio = (CT primary /CT Secondary)

8.2 Limit Switch :

Limit switch can be used to monitor the measured parameter (Ref.Table 2;)in relation with to a set limit.

The limit switch can be configured in one of the four mode given below:-

- 1) Hi alarm & Relay Energized Relay..
- 2) Hi alarm & De-Energized Relay.
- 3) Lo alarm & Energized Relay.
- 4) Lo alarm & De-Energized Relay.

Hi Alarm:

If Hi-Alarm Energized or Hi Alarm De-Energized option is selected then relay will get energized or De-energized,if selected parameter is greater than or equal to trip point.

Lo Alarm:

If Lo-Alarm Energized or Lo Alarm De-Energized option is selected then relay will get energized or De-energized,if selected parameter is less than or equal to trip point.

Trip point :

Trip point can be set in the range of 10% to % 120 of nominal value for Hi-Alarm & 10% to 100 % of nominal value for Lo-Alarm.

Hysteresis :

Hysteresis can be set in the range of 0.05% to % 50 of set trip point. If Hi-alarm Energized or Hi-alarm De-energized is selected then relay will get De-energized or Energized respectively ,if set parameter value is less than Hysteresis Similarly if Lo-alarm Energized or Lo-alarm De-Energized.

Energizing Delay :

The energizing delay can be set in the range from 1to 10 sec.

De-Energizing Delay :

The De-energizing delay can be set in the range from 1to 10 sec.

Note : In case of lo alarm if trip point is set at 100% then maximum 20% Hysteresis can be set.

Example of different configuration.

Parameter No * : (Current¹)

Trip Point^Δ : % =

Hysteresis Δ : % = of trip point

Energising Delay* : s

De-energising Delay* : s

1) Hi alarm & Energised relay

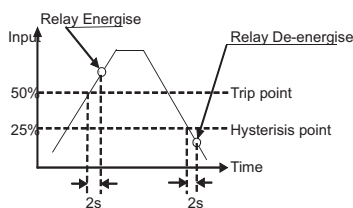

2) Hi alarm & De-energised relay

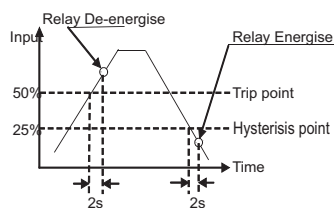

3) Lo alarm & Energised relay

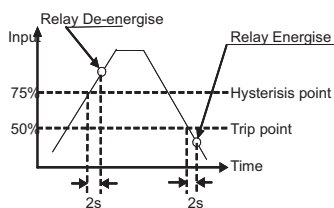

4) Lo alarm & De-energised relay

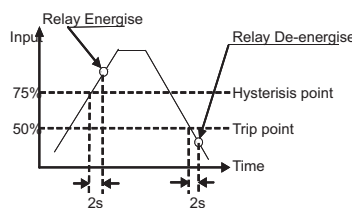

9. RS 485 (ModBus) Output :

3440 supports MODBUS (RS485) RTU protocol(2-wire) .

Connection should be made using twisted pair shielded cable .All " A "and" B "connections are daisy chained together .The screens should also be connected to the " Gnd "terminal .To avoid the possibility of loop currents , an Earth connection should be made at one point on the network.Loop(ring) topology does not require any termination load .Line topology may or may not require terminating loads depending on the type and length of cable used .The impedance of the termination load should match the impedance of the cable and be at both ends of the line .The cable should be terminated at each end with a 120 ohm (1/4Watt min.) resistor .

RS 485 network supports maximum length of 1.2 km .Including the Master ,a maximum of 32 instruments can be connected in RS 485network.The permissible address range for 3440 is between 1 and 247 for 32 instruments . Broadcast Mode (address 0) is not allowed.

The maximum latency time of an 3440 is 200 ms i.e .this is the amount of time that can pass before the first response character is output.

After sending any query through software (of the Master) , it must allow 200 ms of time to elapse before assuming that the 3440 is not going to respond .If slave does not respond within 200 ms , Master can ignore the previous query and can issue fresh query to the slave.

The each byte in RTU mode has following format:

	8-bit binary, hexadecimal 0-9, A-F 2 hexadecimal characters contained in each 8-bit field of the message
Format of Data Bytes	4 bytes (32 bits) per parameter. Floating point format (to IEEE754) Most significant byte first (Alternative least significant byte first)
Error Checking Bytes	2 byte Cyclical Redundancy Check (CRC)
Byte format	1 start bit, 8 data bits, least significant bit sent first 1 bit for even/odd parity 1 stop bit if parity is used; 1 or 2 bits if no parity

Communication Baud Rate is user selectable from the front panel between ,9600 ,4800 ,2400 19200 bps.

Function code:

03	Read Holding Registers	Read content of read/ write location (4 X)
04	Read input Registers	Read content of read only location (3 X)
16	Presets Multiple Registers	Set the content of read / write locations (4 X)

01	Illegal function	The function code is not supported by 3440
02	Illegal Data Address	Attempt to access an invalid address or an attempt to read or write part of a floating point value
03	Illegal Data Value	Attempt to set a floating point variable to an invalid value

Exception Cases : An exception code will be generated when 3440 receives ModBus query with valid parity & error check but which contains some other error (e.g. Attempt to set floating point variable to an invalid value) The response generated will be "Function code" ORed with HEX (80H). The exception codes are listed below

Accessing 3 X register for reading measured values :

Two consecutive 16 bit registers represent one parameter .Refer table 4 for the addresses of 3 X registers (Parameters measured by the instruments). Each parameter is held in the 3 X registers .Modbus Code 04 is used to access all parameters .

Example:

To read parameter,
Volts : Start address 04 =(Hex) Number of registers 02 =

Note : Number of registers = Number of parameters x

Each Query for reading the data must be restricted to 20 parameters or less .Exceeding the 20 parameter limit will cause a ModBus exception code to be returned.

Query:

01 (Hex)	04 (Hex)	00 (Hex)	04 (Hex)	00 (Hex)	02 (Hex)	30 (Hex)	0A (Hex)
Device Address	Function Code	Start Address High	Start Address Low	Number of Registers Hi	Number of Registers Lo	CRC Low	CRC High

Start Address High : Most significant 8 bits of starting address of the parameter requested.

Start Address low: Least significant 8 bits of starting address of the parameter requested.

Number of register Hi : Most significant 8 bits of Number of registers requested.

Number of register Lo : Least significant 8 bits of Number of registers requested.

(Note : Two consecutive 16 bit register represent one parameter.)

Response :Volt (219.25V)

01 (Hex)	04 (Hex)	04 (Hex)	43 (Hex)	5B (Hex)	41 (Hex)	21 (Hex)	6F (Hex)	9B (Hex)
Device Address	Function Code	Byte Count	Data Register1 High Byte	Data Register1 Low Byte	Data Register2 High Byte	Data Register2 Low Byte	CRC Low	CRC High

Byte Count : Total number of data bytes received.

Data register 1 High Byte : Most significant 8 bits of Data register 1 of the parameter requested.

Data register 1 Low Byte : Least significant 8 bits of Data register 1 of the parameter requested.

Data register 2 High Byte : Most significant 8 bits of Data register 2 of the parameter requested.

Data register 2 Low Byte : Least significant 8 bits of Data register 2 of the parameter requested.

(Note : Two consecutive 16 bit register represent one parameter.)

Table 3 : 4 X register addresses (measured parameters)

Address (Register)	Parameter No.	Parameter	Modbus Start Address Hex	
			High Byte	Low Byte
30001	1	Volts	00	0
30007	4	Current	00	6
30013	7	W	00	C
30019	10	VA	00	12
30025	13	VAR	00	18
30031	16	PF	00	1E
30037	19	Phase Angle	00	24
30071	36	Freq	00	46
30073	37	Wh Import	00	48
30075	38	Wh Export	00	4A
30077	39	VARh Import	00	4C
30079	40	VARh Export	00	4E
30081	41	VAh	00	50
30083	42	Ah	00	52
30085	43	W Demand)Import(00	54
30087	44	W Max Demand)Import(00	56
30089	45	W Demand)Export(00	58
30091	46	W Max Demand)Export(00	5A
30101	51	VA Demand	00	64
30103	52	VA Max Demand	00	66
30105	53	A Demand	00	68
30107	54	A Max Demand	00	6A
30133	67	Volts Ave Max	00	84
30135	68	Volts Ave Min	00	86
30141	71	Current Ave Max	00	8C
30143	72	Current Ave Min	00	8E
30207	104	V 1THD(%)	00	CE
30213	107	I 1THD(%)	00	D4
30227	114	Run Hour	00	E2
30229	115	On Hour	00	E4
30231	116	No .Of Interrupts	00	E6

Accessing 4 X register for Reading & Writing :

Each setting is held in the 4 X registers. ModBus code 03 is used to read the current setting and code 16 is used to write/change the setting .Refer Table 5 for 4 X Register addresses .

Example : Reading CT Secondary

System type : Start address2 =A)Hex(Number of registers02 =

Note: Number of registers = Number of Parameters x2

Device Address	01 (Hex)
Function Code	03 (Hex)
Start Address High	00 (Hex)
Start Address Low	2A (Hex)
Number of Registers Hi	00 (Hex)
Number of Registers Lo	02 (Hex)
CRC Low	E 5(Hex)
CRC High	C 3(Hex)

Start Address High : Most significant 8 bits of starting address of the parameter requested.

Start Address low: Least significant 8 bits of starting address of the parameter requested.

Number of register Hi : Most significant 8 bits of Number of registers requested.

Number of register Lo : Least significant 8 bits of Number of registers requested.

(Note : Two consecutive 16 bit register represent one parameter.)

Response:

Device Address	01 (Hex)
Function Code	03 (Hex)
Byte Count	04 (Hex)
Data Register 1High Byte	3F (Hex)
Data Register 1Low Byte	80 (Hex)
Data Register 2High Byte	00 (Hex)
Data Register 2Low Byte	00(Hex)
CRC Low	F 7(Hex)
CRC High	CF (Hex)

Byte Count : Total number of data bytes received.

Data register 1 High Byte : Most significant 8 bits of Data register 1 of the parameter requested.

Data register 1 Low Byte : Least significant 8 bits of Data register 1 of the parameter requested.

Data register 2 High Byte : Most significant 8 bits of Data register 2 of the parameter requested.

Data register 2 Low Byte : Least significant 8 bits of Data register 2 of the parameter requested.

)Note : Two consecutive 16 bit register represent one parameter.(

Example : Writing the CT Secondary to 1 amps

System type : Start address2 =A)Hex(Number of registers02 =

Query :Change the CT Secondary to 1 amps

Device Address	01 (Hex)
Function Code	10 (Hex)
Starting Address Hi	00 (Hex)
Starting Address Lo	2A(Hex)
Number of Registers Hi	00 (Hex)
Number of Registers Lo	02(Hex)
Byte Count	04 (Hex)
Data Register 1-High Byte	3F (Hex)
Data Register 1-Low Byte	80(Hex)
Data Register 2-High Byte	00(Hex)
Data Register 2-Low Byte	00(Hex)
CRC Low	7C (Hex)
CRC High	34 (Hex)

Byte Count : Total number of data bytes received.

Data register 1 High Byte : Most significant 8 bits of Data register 1 of the parameter requested.

Data register 1 Low Byte : Least significant 8 bits of Data register 1 of the parameter requested.

Data register 2 High Byte : Most significant 8 bits of Data register 2 of the parameter requested.

Data register 2 Low Byte : Least significant 8 bits of Data register 2 of the parameter requested.

(Note : Two consecutive 16 bit register represent one parameter.)

Response:

Device Address	01 (Hex)
Function Code	10 (Hex)
Start Address High	00 (Hex)
Start Address Low	2A (Hex)
Number of Registers Hi	00 (Hex)
Number of Registers Lo	02 (Hex)
CRC Low	60 (Hex)
CRC High	00 (Hex)

Start Address High : Most significant 8 bits of starting address of the parameter requested.

Start Address low: Least significant 8 bits of starting address of the parameter requested.

Number of register Hi : Most significant 8 bits of Number of registers requested.

Number of register Lo : Least significant 8 bits of Number of registers requested.

(Note : Two consecutive 16 bit register represent one parameter.)



Table 4 : 5 X register addresses

Address Register	Parameter No.	Parameter	Read / Write	Modbus Start Address Hex	
				High Byte	Low Byte
40001	1	Demand Time	R/Wp	00	00
40003	2	Demand Period	R/Wp	00	02
40007	4	Sys Voltage	R	00	06
40009	5	Sys Current	R	00	08
40013	7	Pulse Width	R/Wp	00	0C
40015	8	Energy Reset	Wp	00	0E
40017	9	Run/On Hour & Interruption Reset	Wp	00	10
40019	10	RS 485 Set-up Code	R/Wp	00	12
40021	11	Node Address.	R/Wp	00	14
40023	12	Pulse Divisor	R/Wp	00	16
40025	13	Min Reset	Wp	00	18
40027	14	Max Reset	Wp	00	1A
40029	15	Analog Out -1 Para Sel	R/Wp	00	1C
40031	16	Analog Out -2 Para Sel	R/Wp	00	1E
40033	17	PT Primary	R/Wp	00	20
40035	18	CT Primary	R/Wp	00	22
40037	19	System Power	R	00	24
40041	21	Register Order/Word Order	R/Wp	00	28
40043	22	CT Secondary	R/Wp	00	2A
40045	23	PT Secondary	R/Wp	00	2C
40047	24	Relay 1output select	R/Wp	00	2E
40049	25	Pulse/1Limit 1Parameter select	R/Wp	00	30
40051	26	Limit 1Trip point	R/Wp	00	32
40053	27	Hysteresis)Limit1(R/Wp	00	34
40055	28	Limit 1delay)On(R/Wp	00	36
40057	29	Limit 1delay)Off(R/Wp	00	38
40059	30	Relay 2output select	R/Wp	00	3A
40061	31	Pulse/2Limit 2Parameter select	R/Wp	00	3C
40063	32	Limit 2Trip point	R/Wp	00	3E
40065	33	Hysteresis)Limit2(R/Wp	00	40
40067	34	Limit 2Delay)On(R/Wp	00	42
40069	35	Limit 2Delay)Off(R/Wp	00	44
40071	36	Password	R/W	00	46
40073	37	Limit 1Configuration select	R/Wp	00	48
40075	38	Limit 2Configuration select	R/Wp	00	4A
40077	39	Auto scroll	R/Wp	00	4C
40079	40	30mA Noise Current Elimination	R/Wp	00	4E

40025	Min - Reset	This address is used to reset the Min parameters value . Write Zero value to this register to reset the Min parameters . Writing any other value will return an error.
40027	Max - Reset	This address is used to reset the Max parameters value . Write Zero value to this register to reset the Max parameters . Writing any other value will return an error.
40029	Analog Out-1 Para Set	This address is used to set the parameter for Analog Output.1 Write one of the parameter no .As per the options given in Table 2 for Analog & Limit Output Parameters. Writing any other value will return an error.
40031	Analog Out-2 Para Set	This address is used to set the parameter for Analog Output.2 Write one of the parameter no .As per the options given in Table 2 for Analog & Limit Output Parameters. Writing any other value will return an error.
40033	PT Primary	This address allows the user to set PT Primary value. The maximum settable value is 9999 also depends on the per phase 666.6MVA Restriction of power combined with CT primary.
40035	CT Primary	This address allows the user to set CT Primary value. The maximum settable value is 9999 also depends on the per phase 666.6 MVA Restriction of power combined with PT primary
40037	Sys Power	System Power (Read Only) is the Nominal system power based on the values of Nominal system volts and Nominal system current.
40041	Word Order	Word Order controls the order in which 3440 receives or sends floating - point numbers -normal or reversed register order . In normal mode, the two registers that make up a floating point numbers are sent most significant bytes first. In reversed register mode , the two registers that make up a floating point numbers are sent least significant bytes first. To set the mode ,write the value '2141.0' into this register- the instrument will detect the order used to send this value and set that order for all ModBus transaction involving floating point numbers.
40043	CT secondary	This address is used to read and write the CT secondary value write one of the following values to this address. 1=1A CT secondary 5=5A CT secondary writing any other value will return an error.
40045	PT secondary	This address is used to read and write the PT secondary value. Ref Table for the range of PT secondary settable values in Section 3.2.1.2
40047	Relay 1output select	This address is used to select the Relay 1 operation as pulse or Limit . write one of the following values to this address. 0 = Pulse output on Relay 1 128 (Decimal) = Limit output on Relay 1 writing any other value will return an error.
40049	Pulse/1Limit1 parameter select	This address is used to assign the Parameter to Relay1 If Limit option is selected refer table 2 for parameter number &if Pulse option is selected then refer table .7
40051	Limit 1 Trip Point	This address is used to set the trip point in .% Any value between 10 to 100 for Lo- alarm & 10 to120 for Hi-alarm can be written to this address. Writing any other value will return an error.
40053	Hysteresis)Limit1(This address is used to set the hysteresis between 0.5 to 50 . Writing any other value will return an error.
40055	Limit 1 Energizing Delay	This address is used to set the Energizing delay between 1 to 10 . Writing any other value will return an error.
40057	Limit 1 de-energizing Delay	This address is used to set the De-Energizing delay between 1 to 10 . Writing any other value will return an error.
40059	Relay 2 output select	This address is used to select the Relay 2 operation as pulse or Limit . write one of the following values to this address. 0 = Pulse output on Relay 2 128 (decimal) = Limit output on Relay 2 writing any other value will return an error.
40061	Pulse/2Limit2 Parameter select	This address is used to assign the Parameter to Relay2 If Limit option is selected refer table 2 for parameter number &if Pulse option is selected then refer table .7
40063	Limit 2 Trip point	This address is used to set the trip point in .% Any value between 10 to 100 for Lo- alarm & 10 to120 for Hi-alarm can be written to this address. Writing any other value will return an error.
40065	Hysteresis)Limit2(This address is used to set the hysteresis between 0.5 to 50 . Writing any other value will return an error.
40067	Limit 2 Energizing delay	This address is used to set the Energizing delay between 1 to 10 . Writing any other value will return an error.
40069	Limit 2 De-Energizing delay	This address is used to set the De-Energizing delay between 1 to 10 . Writing any other value will return an error.

Explanation for 4 X register:

Address	Parameter	Description
40001	Demand Reset	Demand Reset is used to reset the Demand parameter .A value of zero must be Written to this register to reset the Demand period .Writing any other value will return an error.
40003	Demand Period	Demand period represents demand time in minutes .The applicable values are 8,15,20 or .30 Writing any other value will return an error .
40007	System Voltage	This address is read only and displays System Voltage
40009	System Current	This address is read only and displays System Current
40013	Pulse Width of Relay	This address is used to set pulse width of the Pulse output . Write one of the following values to this address: 60 60 :ms 100 100 :ms 200 200 :ms Writing any other value will return error.
40015	Reset Energy Counter	This address is used to reset the Energy Counter . Write zero value to this register to reset the energy counter . Writing any other value will return an error.
40017	Run/On Hour& Interruption reset	This address is used to reset the Run/On hour & number of Interruption . Write zero value to this register to reset the Run/On hour & number of Interruption. Writing any other value will return an error.
40019	Rs 485Set-up Code	This address is used to set the baud rate ,Parity ,Number of stop bits . Refer to Table 6 for details.
40021	Node Address	This register address is used to set Device address between 1 to 247 .
40023	Pulse Divisor	This address is used to set pulse divisor of the Pulse output . Write one of the following values to this address: 1 :Divisor1 10 :Divisor10 100 :Divisor100 1000 : Divisor 1000 Writing any other value will return an error.

Address	Parameter	Description
40071	Password	This address is used to set & reset the password . Valid Range of Password can be set is. 9999 - 0000 1) If password lock is present & if this location is read it will return zero. 2) If Password lock is absent & if this location is read it will return One. 3) If password lock is present & to disable this lock first send valid password to this location then write "0000" to this location 4) If password lock is present & to modify 4X parameter first send valid password to this location so that 4X parameter will be accessible for modification. 5) If for in any of the above case invalid password is send then meter will return exceptional error 2.
40073	Limit1 Configuration Select	This address is used to set the Configuration for relay1 see table . 8 Writing any other value will return an error .
40075	Limit2 Configuration Select	This address is used to set the Configuration for relay2 see table . 8 Writing any other value will return an error .
40077	Auto scroll	This address is used to activate or de-activatethe auto scrolling write 0-Deactivate 1-Activate Writing any other value will return an error .
40079	30mA Noise current Elimination	This address is used to activate or de-activatethe 30 mA noise current elimination write 0-Deactivate 30 (Decimal)-Activate Writing any other value will return an error .

Table : RS Set-up Code

Baud Rate	Parity	Stop Bit	Decimal value
19200	NONE	01	12
19200	NONE	02	13
19200	EVEN	01	14
19200	ODD	01	15
9600	NONE	01	08
9600	NONE	02	09
9600	EVEN	01	10
9600	ODD	01	11
4800	NONE	01	04
4800	NONE	02	05
4800	EVEN	01	06
4800	ODD	01	07
2400	NONE	01	00
2400	NONE	02	01
2400	EVEN	01	02
2400	ODD	01	03

NOTE :
Codes not listed in the table above may give rise to unpredictable results including loss of communication .Excise caution when attempting to change mode via direct Modbus writes.

Table : Pulse & Pulse Configuration select

Code	Configuration
0	Import Active Energy
1	Export Active Energy
2	Import Reactive Energy
3	Export Reactive Energy
4	Apparent Energy

Table: Limit & Limit Configuration select

Code	Configuration
0	Hi -alarm & Enegised relay
1	Hi -alarm & Denegised relay
2	Lo -alarm & Enegised relay
3	Lo -alarm & Denegised relay

9.1 User Assignable Modbus Registers:

The 3440 contains the 20 user assignable registers in the address range of 0x200 (30513) to 0x226 (30551) (see Table9).

Any of the parameter addresses (3X register addresses Table 4) accessible in the instrument can be mapped to these 20 user assignable registers.

Parameters (3X registers addresses) that resides in different locations may be accessed by the single request by re-mapping them to adjacent address in the user assignable registers area .

The actual address of the parameters (3X registers addresses) which are to be assessed via address0 x 200to0 x 226are specified in4 x Register0 x 200to0 x 213(see Table10).

Table : 9 User Assignable3 X Data Registers

Address (Register)	Parameter Number.	Assignable Register	Modbus Start Address (Hex)	
			High Byte	Low Byte
30513	257	Assignable Reg1	02	00
30515	258	Assignable Reg2	02	02
30517	259	Assignable Reg3	02	04
30519	260	Assignable Reg4	02	06
30521	261	Assignable Reg5	02	08
30523	262	Assignable Reg6	02	0A
30525	263	Assignable Reg7	02	0C
30527	264	Assignable Reg8	02	0E
30529	265	Assignable Reg9	02	10
30531	266	Assignable Reg10	02	12
30533	267	Assignable Reg11	02	14
30535	268	Assignable Reg12	02	16
30537	269	Assignable Reg13	02	18
30539	270	Assignable Reg14	02	1A
30541	271	Assignable Reg15	02	1C
30543	272	Assignable Reg16	02	1E
30545	273	Assignable Reg17	02	20
30547	274	Assignable Reg18	02	22
30549	275	Assignable Reg19	02	24
30551	276	Assignable Reg20	02	26

Table : 10 User Assignable mapping register (4 X registers)

Address (Register)	Parameter Number.	Mapping Register	Modbus Start Address (Hex)	
			High Byte	Low Byte
40513	257	Mapped Add for register#0 x0200	02	00
40514	258	Mapped Add for register#0 x 0202	02	01
40515	259	Mapped Add for register#0 x0204	02	02
40516	260	Mapped Add for register#0 x0206	02	03
40517	261	Mapped Add for register#0 x0208	02	04
40518	262	Mapped Add for register#0 x020A	02	05
40519	263	Mapped Add for register#0 x020C	02	06
40520	264	Mapped Add for register#0 x020E	02	07
40521	265	Mapped Add for register#0 x0210	02	08
40522	266	Mapped Add for register#0 x0212	02	09
40523	267	Mapped Add for register#0 x0214	02	0A
40524	268	Mapped Add for register#0 x0216	02	0B
40527	269	Mapped Add for register#0 x0218	02	0C
40528	270	Mapped Add for register#0 x021A	02	0D
40529	271	Mapped Add for register#0 x021C	02	0E
40530	272	Mapped Add for register#0 x021E	02	0F
40531	273	Mapped Add for register#0 x0220	02	10
40532	274	Mapped Add for register#0 x0222	02	11
40533	275	Mapped Add for register#0 x0224	02	12
40534	276	Mapped Add for register#0 x0226	02	13

Example:

Assigning parameter to user assignable registers

To access the voltage (3X address0 x0000) and Power Factor (3X address0 x001E) through user assignable register assign these addresses to4 x register (Table 10)0 x 0200and0 x 0201respectively.

Assigning Query:

Device Address	01 (Hex)
Function Code	10 (Hex)
Starting Address Hi	02 (Hex)
Starting Address Lo	00 (Hex)
Number of Registers Hi	00 (Hex)*
Number of Registers Lo	02(Hex)*
Byte Count	04 (Hex)
Data Register1-High Byte	00 (Hex)
Data Register 1-Low Byte	00 (Hex)
Data Register 2-High Byte	00 (Hex)
Data Register 2-Low Byte	1E (Hex)
CRC Low	6A (Hex)
CRC High	CV)Hex(

} Voltage*
)3X Address0 x0000(
 } Power Factor*
)3X Address0 x001E(

*Note : Parameters should be assigned in Multiple of two i.e .20.....2,4,6,8 .

Response:

Device Address	01 (Hex)
Function Code	10 (Hex)
Start Address High	02 (Hex)
Start Address Low	00 (Hex)
Number of Registers Hi	00 (Hex)
Number of Registers Lo	02 (Hex)
CRC Low	40 (Hex)
CRC High	70 (Hex)

Reading Parameter data through User Assignable Registers:

In assigning query Voltage and Power Factor parameters were assigned to 0x200 and 0x201 (Table 10) which will point to user assignable 3 registers 0x200 and 0x202 (Table 9). So to read Voltage and Power Factor data reading query should be as below.

Query:

Device Address	01 (Hex)
Function Code	04 (Hex)
Start Address High	02 (Hex)
Start Address Low	00 (Hex)
Number of Registers Hi	00 (Hex)
Number of Registers Lo	04 (Hex) **
CRC Low	F0 (Hex)
CRC High	71 (Hex)

Start Address High : Most significant 8 bits of starting address of User assignable register .
 Start Address low: Least significant 8 bits of starting address of User assignable register .
 Number of register Hi : Most significant 8 bits of Number of registers requested.
 Number of register Lo : Least significant 8 bits of Number of registers requested.

****Note : Two consecutive 16 bit register represent one parameter. Since two parameters are requested four registers are required**

Response : Voltage / 219.30 = Power Factor 1.0 = (

Device Address	01 (Hex)
Function Code	04 (Hex)
Byte count	08 (Hex)
Data Register 1-High Byte	43 (Hex)
Data Register 1-Low Byte	5B (Hex)
Data Register 2-High Byte	4E (Hex)
Data Register 2-Low Byte	04 (Hex)
Data Register 3-High Byte	3F (Hex)
Data Register 3-Low Byte	80 (Hex)
Data Register 4-High Byte	00 (Hex)
Data Register 4-Low Byte	00 (Hex)
CRC Low	79 (Hex)
CRC High	3F (Hex)

Voltage Data

Power Factor Data

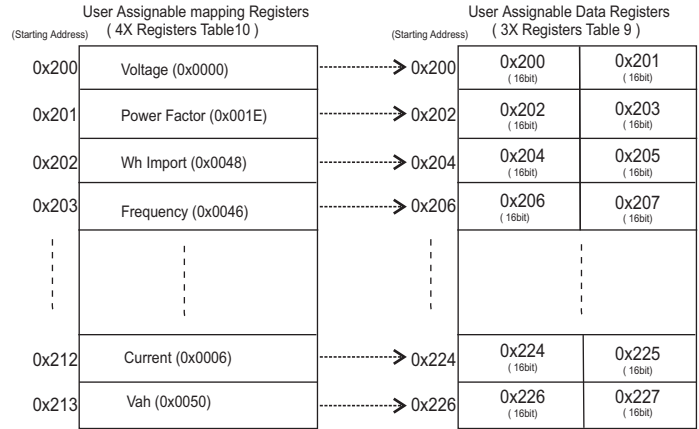

To get the data through User assignable Register use following steps:

- 1) Assign starting addresses (Table 3) of parameters of interest to a "User assignable mapping registers" in a sequence in which they are to be accessed (see section "Assigning parameter to user assignable registers")
- 2) Once the parameters are mapped data can be acquired by using "User assignable data register" Starting address . i.e to access data of Voltage, Power factor, Wh import, Frequency send query with starting address 0x200 with number of register 8 or individually parameters can be accessed for example if current 1 to be accessed use starting address 0x212. (See section Reading Parameter data through User Assignable Registers)

10. Phasor Diagram :

- Quadrant 1: 0° to 90°
- Quadrant 2: 90° to 180°
- Quadrant 3: 180° to 270°
- Quadrant 4: 270° to 360°

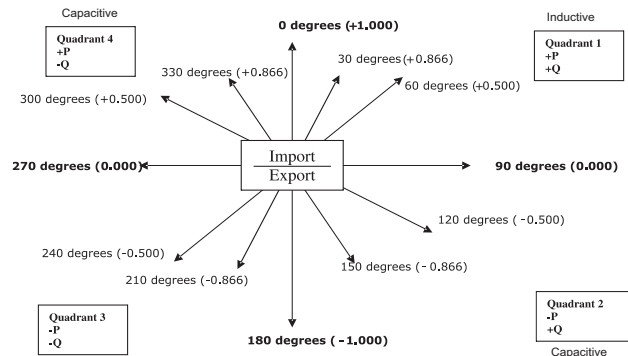

Connections	Quadrant	Sign of Active Power (P)	Sign of Reactive Power (Q)	Sign of Power Factor (PF)	Inductive/ Capacitive
Import	1	+P	+Q	+	L
Import	4	+P	-Q	+	C
Export	2	-P	+Q	-	C
Export	3	-P	-Q	-	L

Inductive means Current lags V oltage
 Capacitive means Current leads V oltage

When "++" displays Active power (P) with " + " (positive sign) , the connection is " Import " .

When "--" displays Active power (P) with " - " (negative sign) , the connection is " Export " .

11. Installation

Mounting is by four side clamps ,slide the side clamps through side slot till side clamp gets firmly locked in a groove (Refer fig.) Consideration should be given to the space required behind the instrument to allow for bends in the connection cables.

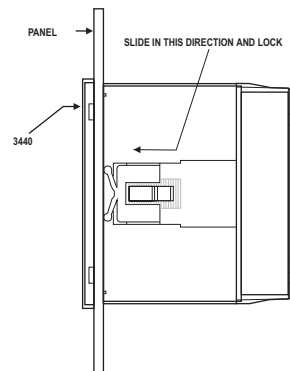

As the front of the enclosure conforms to IP 54 it is protected from water spray from all directions, additional protection to the panel may be obtained by the use of an optional panel gasket. The terminals at the rear of the product should be protected from liquids.

The meter should be mounted in a reasonably stable ambient temperature and where the operating temperature is within the range -10 to 55°C. Vibration should be kept to a minimum and the product should not be mounted where it will be subjected to excessive direct sunlight.

Caution

- In the interest of safety and functionality this product must be installed by a qualified engineer, abiding by any local regulations.
- Voltages dangerous to human life are present at some of the terminal connections of this unit. Ensure that all supplies are de-energised before attempting any connection or disconnection.
- These products do not have internal fuses therefore external fuses must be used to ensure safety under fault conditions.

11.1 EMC Installation Requirements

This product has been designed to meet the certification of the EU directives when installed to a good code of practice for EMC in industrial environments, e.g.

- Screened output and low signal input leads or have provision for fitting RF suppression components, such as ferrite absorbers, line filters etc., in the event that RF fields cause problems.

Note: It is good practice to install sensitive electronic instruments that are performing critical functions, in EMC enclosures that protect against electrical interference which could cause a disturbance in function.

- Avoid routing leads alongside cables and products that are, or could be, a source of interference.
- To protect the product against permanent damage, surge transients must be limited to 1 kV pk. It is good EMC practice to suppress differential surges to 1 kV at the source. The unit has been designed to automatically recover in the event of a high level of transients. In extreme circumstances it may be necessary to temporarily disconnect the auxiliary supply for a period of greater than 2 seconds to restore correct operation. The Current inputs of these products are designed for connection in to systems via Current Transformers only, where one side is grounded.
- ESD precautions must be taken at all times when handling this product.

11.2 Case Dimension and Panel Cut Out

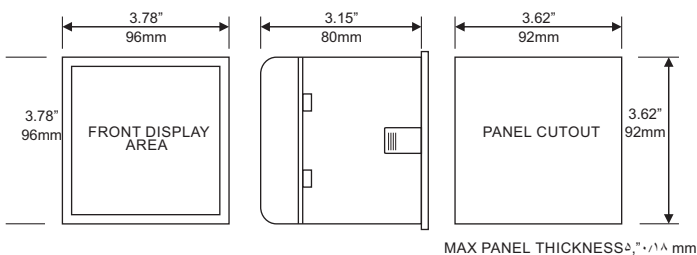

11.3 Wiring

Input connections are made directly to screw-type terminals with indirect wire pressure. Numbering is clearly marked in the plastic moulding. Choice of cable should meet local regulations. Terminal for both Current and Voltage inputs will accept upto 2.5mm diameter cables.

Note: It is recommended to use wire with lug for connection with meter.

11.4 Auxiliary Supply

3440 should ideally be powered from a dedicated supply, however it may be powered from the signal source, provided the source remains within the limits of the chosen auxiliary voltage.

11.5 Fusing

It is recommended that all voltage lines are fitted with 1 amp HRC fuses.

11.6 Earth/Ground Connections

For safety reasons, CT secondary connections should be grounded in accordance with local regulations.

12. Connection Diagram :

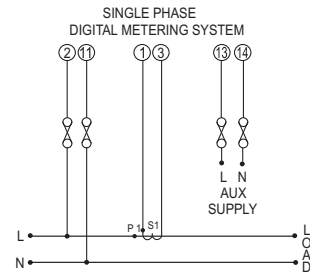

13. Specification :

Inputs

Nominal input voltage	57.7 V _{L-N} to 277V _{L-N}
Max continuous input voltage	120% of Rated Value
Max short duration input voltage	2 x Rated Value (1s application repeated 10 times at 10s intervals)
Nominal input voltage burden	0.2VA Approx.
Nominal input current	1A / 5A AC rms programmable at site
Max continuous input current	120 % of Rated Value
Nominal input current burden	0.6VA Approx.
Max short duration current input	20 x Rated Value (1s application repeated 5 times at 5 min. intervals)
System CT primary values	Std. Values from 1 to 1000 A (1 or 2 Amp secondaries)

Auxiliary

Standard nominal Auxillary supply voltages & Frequency	110V AC/50 Hz, 230V AC/50 Hz, 380V AC/50 Hz, 100 - 250V AC-DC, 12 - 48V DC
a.c. supply voltage tolerance	% ± of Rated Value
a.c. supply frequency range	45 to 66 Hz
a.c. supply burden	4.5VA
d.c. supply burden	3W

Operating Measuring Ranges

Voltage	5 .. 120 % of Rated Value
Current	5 .. 120 % of Rated Value
Frequency	40 .. 70 Hz
Power Factor	0.5 Lag ... 1 ... 0.8 Lead

Accuracy

Accuracy	± 0.1%
Voltage	% ± of range
Current	% ± of range
Frequency	0.15% of mid frequency
Active Power	% ± of range
Re -Active Power	% ± of range
Apparent Power	% ± of range
Active Energy	% ± of range
Re - Active Energy	% ± of range
Apparant Energy	% ± of range
Power Factor	% ± of Unity
Angle	% ± of range
Analog Output	% ± of Output end value
Total harmonic Distortion	% ±

Accuracy: ±0.5	
Voltage	±0.5% of range
Current	±0.5% of range
Frequency	0.15% of mid frequency
Active Power	±0.5% of range
Re -Active Power	±0.5% of range
Apparent Power	±0.5% of range
Active Energy	±0.5% of range
Re - Active Energy	±0.5% of range
Apparant Energy	±0.5% of range
Power Factor	±0.1 of Unity
Angle	±0.1 of range
Analog Output	±0.1% of Output end value
Total harmonic Distortion	±0.1%

Accuracy: ±1	
Voltage	±1% of range
Current	±1% of range
Frequency	0.15% of mid frequency
Active Power	±1% of range
Re -Active Power	±1% of range
Apparent Power	±1% of range
Active Energy	±1% of range
Re - Active Energy	±1% of range
Apparant Energy	±1% of range
Power Factor	±0.1 of Unity
Angle	±0.1 of range
Analog Output	±0.1% of Output end value
Total harmonic Distortion	±0.1%

Reference conditions for Accuracy :

Reference temperature	23°C ± 2°C
Input frequency	50 or 60Hz ± 2%
Input waveform	Sinusoidal (distortion factor ≤ 0.05)
Auxiliary supply voltage	Rated Value ± 1%
Auxiliary supply frequency	Rated Value ± 1%
Voltage Range	50...100% of Nominal Value. 60...100% of Nominal Value for THD.
Current Range	10...100% of Nominal Value. 20...100% of Nominal Value for THD.
Power	$\cos \phi / \sin \phi =$ For Active / Reactive Power & Energy 10... 100% of Nominal Current & 50... 100% of Nominal Voltage
Power Factor / Phase Angle	40... 100% of Nominal Current & 50... 100% of Nominal Voltage

Nominal range of use of influence quantities for measurands

Voltage	50 .. 120 % of Rated Value
Current	10 .. 120 % of Rated Value
Input frequency	Rated Value ± 1%
Temperature	0 to 50°C
Auxiliary supply voltage	Rated Value ± 1%
Auxiliary supply frequency	Rated Value ± 1%
Temperature Coefficient (For Rated value range of use 0... 50 C)	0.025% / °C for Voltage (50..120% of Rated Value) 0.05% / °C for Current (10..120% of Rated Value)
Error change due to variation of an influence quantity	2 * Error allowed for the reference condition applied in the test.

Display

LED Update	3 line 4 digits . Digit height 11mm Approx 1 .seconds
------------	--

Controls

User Interface	Two push buttons
----------------	------------------

Standards

EMC Immunity	IEC 61326 10V/m min-Level 3 industrial low level electromagnetic radiation environment IEC 61000-4-3
--------------	---

Safety

	IEC 61010-1 Year 2011
--	-----------------------

IP for water & dust

	IEC 60529
--	-----------

Isolation

Dielectric voltage withstand test between circuits and accessible surfaces	2.2 kV RMS 50 Hz for 1 minute according to DINEN 61010-1 between 1)Input circuit(voltage/current) & AUX & Analog output & pulse output Versus Case 2)Voltage input circuit & AUX Versus Current input circuit 3)Voltage input circuit Versus AUX 4)Input circuit(voltage/current) Versus Analog output & RS & Pulse output NOTE :Analog output and RS are not isolated .
--	---

Environmental

Operating temperature	0 to 55°C
Storage temperature	-20 to 75°C
Relative humidity	0 .. 90 % RH
Warm up time	3 minute (minimum)
Shock	15g in 3 planes
Vibration	10 .. 55 Hz, 0.15mm amplitude
Enclosure (front only)	IP 54 as per IEC 60529

Enclosure

Style	96mm x 96mm DIN Quadratic
Material	Polycarbonate Housing, Self extinguish & non dripping as per UL 94 V 0
Terminals	Screw-type terminals
Depth	40 >mm
Weight	0.620 kg Approx.

14. Connection for Optional Pulse Output / RS 485 / Analog Output (rear view of 3440):

7. RS 485 +

Pulse output Option) \ or \ Relay (:

Relay	1NO + 1NC
Switching Voltage & Current	240VDC , 5Amp.
Default Pulse rate Divisor	1 per Wh (up to 3600W), 1 per kWh (up to 3600kW), 1 per MWh (above 3600 kW)
Pulse rate Divisors	Programmable on site
10	1 per 10Wh (up to 3600W), 1 per 10kWh (up to 3600kW), 1 per 10MWh (above 3600 kW)
100	1 per 100Wh (up to 3600W), 1 per 100kWh (up to 3600kW), 1 per 100MWh (above 3600 kW)
1000	1 per 1000Wh (up to 3600W), 1 per 1000kWh (up to 3600kW), 1 per 1000MWh (above 3600 kW)
Pulse Duration	60ms , 100ms or 200ms

Note : Above conditions are also applicable for Reactive & Apparent Energy.

ModBus) RS⁺RS⁻ (Option:

Protocol	ModBus) RS ⁺ RS ⁻ (
Baud Rate	19200 , 9600 , 4800 or 2400) Programmable (
Parity	Odd or Even ,with \ stop bit, or None with \ or \ stop bits

Analog Output Option:

Linear	0 ... 1mA dc into 0 - 2 kohm Uni-directional ,internally powered.
	4 ... 20mA dc into 0 - 500 ohm Uni-directional ,internally powered .

1. One Pulse Output (One Limit Output)



2. Two Pulse Output (Two Limit Output)

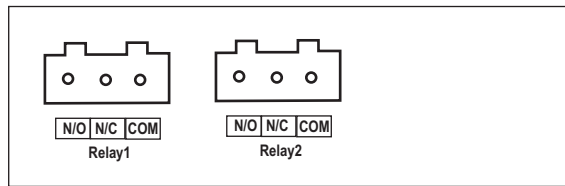

3. RS 485 Output



4. Two Analog Output



5. One Pulse (One Limit) + RS 485 Output

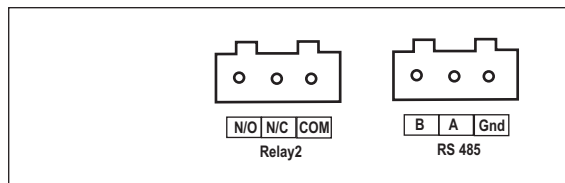

6. One Pulse (One Limit) + Two Analog Output

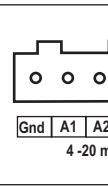
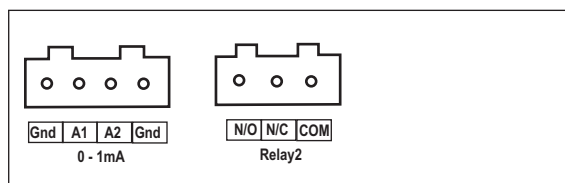

8. RS 485 Output

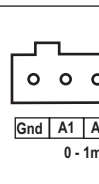

9. Two Pulse

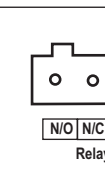

The Information contained in this document is intended to describe the product. It is the user's responsibility to verify the information.

19